

PUMP SYSTEMS

Energy Efficiency Reference Guide

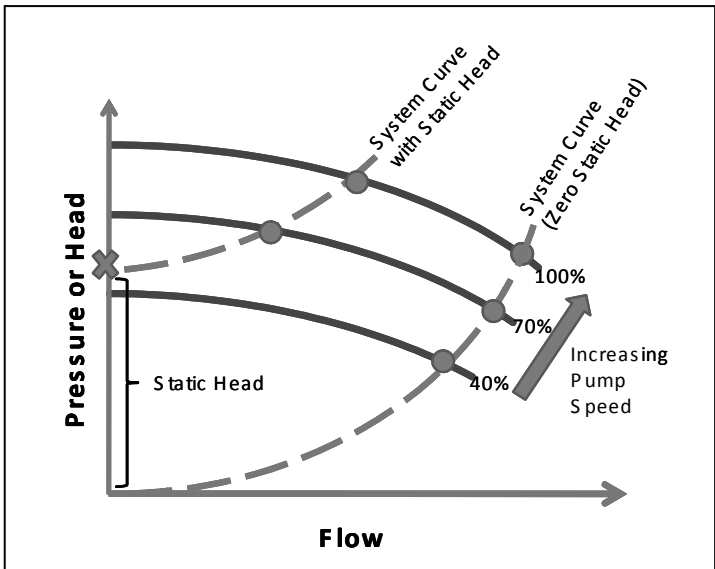

DISCLAIMER: Neither CEATI International Inc., the authors, nor any of the organizations providing funding support for this work (including any persons acting on the behalf of the aforementioned) assume any liability or responsibility for any damages arising or resulting from the use of any information, equipment, product, method or any other process whatsoever disclosed or contained in this guide.

The use of certified practitioners for the application of the information contained herein is strongly recommended.

This guide was prepared by Ivor da Cunha P.Eng., Terry Strack P.Eng., and Saul Stricker P.Eng. of LeapFrog Energy Technologies Inc. for the CEATI Customer Energy Solutions Interest Group (CESIG) with the sponsorship of the following utility consortium participants:



© 2008 CEATI International Inc. All rights reserved.

Appreciation to Ontario Hydro, Ontario Power Generation and others who have contributed material that has been used in preparing this guide.

TABLE OF CONTENTS

Section		Page
1	Purpose of this Guide	5
2	How this Guide is Organized	7
a.	Guide Organization	7
b.	Getting the Most from this Guide	9
3	Introduction	11
4	Selection and Application of Pumps	13
5	Classification of Pumps and Pump Types	17
a.	Kinetic Rotodynamic Pumps	19
b.	Positive Displacement Pumps	23
6	Understanding the Theory of Pumps	27
a.	Pump Affinity Laws	34
b.	Cavitation	38
7	Pump Controls	41
a.	Throttle Valves	41
b.	Bypass Valves	43
c.	Pump Speed Control	44
d.	Multiple Pump Configurations	47
e.	Pump Output Power	48
8	Introduction to Adjustable Speed Drives	49

	a. Adjustable Speed Drive Operating Considerations	54
9	Parallel & Series Operation	55
	a. Pumps Connected in Series	55
	b. Pumps Connected in Parallel	56
10	Operational and Systems Considerations	59
	a. Energy Optimization - Where to Start	59
	b. Pumping System Efficiency Measures	60
	c. High Efficiency Motors	61
	d. Optimized Pipe Diameter Sizing	62
	e. Optimizing Control Valves	63
	f. Pump Wear and Tear	65
	g. Pump Instability and Drooping	66
11	Energy Savings and Economics	69
	a. System Optimization and Retrofits	71
12	How to Optimize Pump Systems	73
	a. Pump Optimization Prioritization	73
	b. Practical Tips for Pump Optimization	75
	c. Identifying Inefficient Pumps	77
	d. Matching Pump to Motor	77
	e. Trimming Impellers	78
13	Troubleshooting Checklist	81

1 PURPOSE OF THIS GUIDE

You probably wouldn't drive a car with both the accelerator AND the brakes on at the same time. Yet, in many cases, pumping systems do just that – the pump (“accelerator”) and brakes (“throttle valve,” “bypass valve,” or “pipe diameter”) are both engaged simultaneously. This configuration usually gets the job done, but it comes at a huge and often unknown expense in electricity consumption. Many pumping systems were designed or commissioned when energy prices were given little consideration. Advances in pump design, motor performance, control systems, power electronics and monitoring equipment have made it possible for most pumping applications to run at the leading edge. The know-how and technology necessary to design and operate pumping systems in an energy-efficient way are well established and widely available.

This guide is aimed at helping you implement energy efficiency methods and practices involving pumping systems at your location. It will also help you to make informed decisions about operating, maintaining or modifying your existing pump system. It can provide you with some guidance of some high level factors and questions to ask if you are in the process of designing, constructing or commissioning a new pump system. This guide:

- Characterizes various systems.
- Provides a quick reference on performance optimization techniques.
- Provides guidelines on how to pre-screen candidates and perform a feasibility study.

1 Purpose of this Guide

- Reviews field performance testing procedures.

It is common for small- and medium-sized businesses to have multiple pumps installed and operating. As with many situations, the 20:80 rule applies – 20 percent of the pumps use 80 percent of the energy. The corollary is that by finding the trail to the top 20% of the pumps, 80% energy savings can eventually be realized. A simplified prioritization methodology has also been included in the guide to help you with this task.

Caution: As with any electrical or rotating equipment, always use proper safety procedures and lockout procedures before operating, testing or servicing pump system equipment.

2 HOW THIS GUIDE IS ORGANIZED

This guidebook is intended to provide the fundamental information required to make informed and educated decisions about the use and energy efficient operation of pump systems.

Over the lifetime of a typical pump, the value of electricity used can exceed the initial cost by as much as tenfold. Performance optimization of pumps offers tremendous potential for energy savings in the industrial, commercial and institutional sectors. By understanding the relationship between energy and functionality, readers can make informed decisions about the procurement, installation, maintenance and operations of pump systems.

a. Guide Organization

The guide is organized into standalone and related modules. It is expected and recognized that individual readers of this guide have different levels of knowledge and experience with pumps and associated components.

The main themes of the guide are:

Pumping System Fundamentals

For readers who may not be familiar with the essentials of pumps and associated systems, the first section provides a brief discussion of terms, relationships and important system design considerations.

2 How this Guide is Organized

- The main factors for equipment selection and system design are provided, while giving an overview of different types of pumps and their general applications.
- The mechanical theory of how pumps work is presented.
- Energy efficiency concepts are introduced, including a component related to the “affinity rules.” Affinity rules show the relationship between pump rotational speed and flow, pressure or head, and power.
- System and pump curves describe how operating points are determined.

8 Performance Optimization of Pumps and Opportunity Strategies

Optimizing the energy performance of pumps, in most cases, requires that a “systems approach” be taken. The guide considers factors on the pump side as well as the end-use side that can be adjusted or changed in order to optimize energy efficiency and performance.

- The guide addresses the main components of a pump system and opportunities to improve the overall system performance.
- Pump control methods and energy implications of each are discussed together with consideration of pumps operating in parallel and in series.

- Short modules address some of the most common design and operations parameters.
- The guide also addresses the key factors and issues in determining the overall lifetime cost of procuring and operating pumping systems.
- Adjustable speed drives are presented including how they can save energy and money.
- Questions of where to start and how to prioritize which pumps to optimize first are answered through a “pump triage” procedure.
- The guide indicates what to look for when identifying inefficient pumps.
- Pump troubleshooting checklist, worksheets and memory joggers are provided.

Resources and References

The guide also has publication and internet references with hyperlinks for many useful sources of assistance that can help readers to learn more about pump systems. A metric conversion appendix is also included as most pump systems in North America are described using the imperial system of units.

b. Getting the Most from this Guide

This guide has been written with you in mind. We have adapted the material to accommodate:

2 How this Guide is Organized

- Learning styles that require short bursts of relevant information to assimilate knowledge.
- Expectation that many readers need to have practical knowledge in addition to the theoretical knowledge they may or may not already have.
- Use the Internet or online tools for learning new skills or acquiring knowledge.
- Reinforcing key messages and “take away” points.

Energy Efficiency key points are highlighted in a dotted box.

Key points are highlighted in a solid box.

3 INTRODUCTION

By some accounts, between 20% and 50% of the electrical power used by manufacturing facilities is associated with pumps. There is a significant opportunity to achieve higher operating efficiency through improved design, installation, commissioning, operation and maintenance of pump systems.

- Significant opportunities exist to decrease pumping system energy use through smart design, retrofitting and operational practices.
- Pumping applications with variable duty requirements are strong candidates to potentially achieve significant energy savings.
- Pump system savings often go further than energy, and may include improved performance, enhanced reliability and reduced life-cycle costs.
- Common energy saving opportunities associated with pump systems are often overlooked for several reasons including:
 - Energy-saving projects are considered less important than other production-related expenditures.
 - Initial costs taking priority over life-cycle costs.
 - Lack of understanding about pump system operations and maintenance.
 - Low level of awareness about the availability or application of energy-efficient technologies.
 - Misunderstanding of the financial and operational aspects of optimized pump systems.

3 Introduction

Figure 1 shows a simplified cooling system that is typical of many building and industrial cooling layouts. It is common to find throttle valves and bypass valves used for the operation of these systems. The upside is that this control system is easy to set up and usually falls within the “comfort zone” of many designers and building operators. The downside is that excessive use of throttling and bypass valves result in an energy penalty.

Figure 1: Simplified Schematic of Building Cooling System

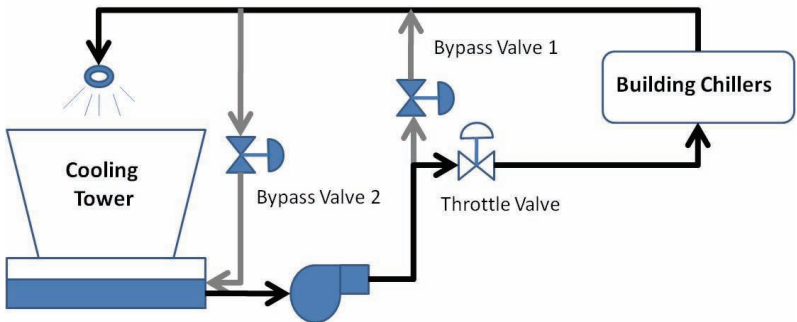

Apart from attention to regular housekeeping and maintenance, some common actions to rectify energy efficiency deficiencies in pumps include:

- Trimming impellers.
- Using high efficiency motors.
- Considering adjustable speed drives.
- Right-sizing equipment.
- Using correct or oversize diameter pipes.
- Shutting pumps down when not required.

4 SELECTION AND APPLICATION OF PUMPS

The pumping system selection process needs to consider the properties of the fluid to be pumped, the pressure and flow requirements over time, and the environmental conditions. Pumping applications include constant or variable flow rate situations, where single or networked loads can be present. Pumping systems may also consist of open loop (once through) or closed loops where the fluid is fully or partially recirculated. The choice of pump can be significantly influenced by the inherent properties of the fluid being pumped. The main considerations as discussed below include:

- Fluid Properties,
- End Use Requirements, and
- Environmental Factors.

Fluid Properties

- **Acidity or Alkalinity** (pH) and material chemical composition. As caustic and acidic fluids can degrade pumps through corrosion, the fluid chemistry must be considered when selecting pump materials.
- **Operating Temperature.** In cases where the pumped fluids may be hotter than 200°F, the pump materials must be evaluated for expansion, mechanical seal components and pump packing integrity.

4 Selection and Application of Pumps

- **Solids Concentrations/Particle Sizes.** Selecting a pump that will not clog or fail prematurely when pumping abrasive liquids such as industrial slurries needs to be evaluated. Principal factors include particle size and hardness, as well as the volumetric percentage of solids.
- **Specific Gravity.** Specific gravity affects the energy necessary to raise and transport the fluid. It needs to be factored when formulating pump power requirements. The fluid's specific gravity is the ratio of the fluid density to that of water under specified temperature and pressure conditions.
- **Vapour Pressure.** Proper consideration of the fluid's vapour pressure will assist to diminish the risk of cavitation. A fluid's vapour pressure is the force per unit area that a fluid exerts in an effort to change phase from a liquid to a vapour. The vapour pressure of a substance increases non-linearly with temperature.
- **Viscosity.** Viscosity of a fluid is a measurement of its opposition to motion. High viscosity fluids result in decreased centrifugal pump performance and increased power requirements. Consideration of the pump suction-side line losses need to be calculated when pumping viscous fluids. Since kinematic viscosity normally varies directly with temperature, the pumping design must take into account the viscosity of the fluid at the lowest anticipated pumping temperature.

End Use Requirements

End-use requirements are in large part determined by system flow and head requirements. Figure 2 shows the suitability of different classes of pumps over an extreme operating range of pressure and flow requirements.

Figure 2: Pump Suitability for Various Flow and Pressure Requirements (Adapted from Pump Institute - not to scale)

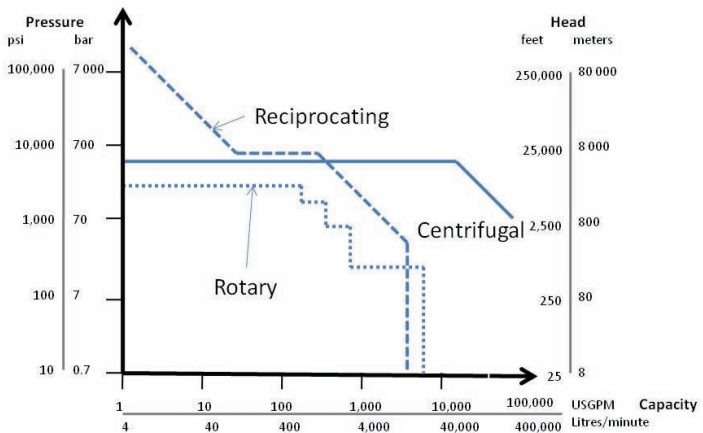

- Design Pump Capacity.** The design pump capacity must be sufficient to meet the required process flow conditions in gallons per minute (GPM) at a certain head pressure. The piping scheme is also needed to accurately establish friction head losses, build a system pressure-flow characteristic curve and decide on a suitable pump and drive motor.

4 Selection and Application of Pumps

- **End-Use Process Requirements.** The end-use process requirements may be fulfilled if the pump supplies a constant flow rate (with on/off control and storage used to satisfy variable flow rate requirements), or by using a throttling valve or variable speed drive to supply variable flow rates. The choice of flow control method may affect system efficiency.
- **Total System Head.** Total system head is comprised of elevation (potential energy), static head and velocity (or dynamic) head. The static head is the pressure of the fluid in the system, and this fluid level can have a substantial impact on system head. Dynamic head is the pressure required by the system to overcome head losses caused by resistance to flow in pipes, fittings, valves and mechanical equipment.

16

Keep in mind that dynamic head losses are roughly proportional to the square of the fluid flow velocity. Hence if the flow rate doubles, dynamic losses increase by a factor of four.

Environmental Factors

Environmental factors that influence pump characteristics and behaviour include ambient temperature and humidity, operating altitude, atmospheric pressure and whether the pump is to be installed inside a building or outdoors.

5 CLASSIFICATION OF PUMPS AND PUMP TYPES

Kinetic (or Rotodynamic) and Positive Displacement (PD) are the two main classes of pumps as defined by their basic principle of operation. Kinetic pumps can be further classified as centrifugal, mixed flow and axial. Positive displacement pumps can be further classified as reciprocating, blow case and rotary. In turn, these pump classes can be further divided as indicated in Figure 3.

Figure 3: Classification of Pumps

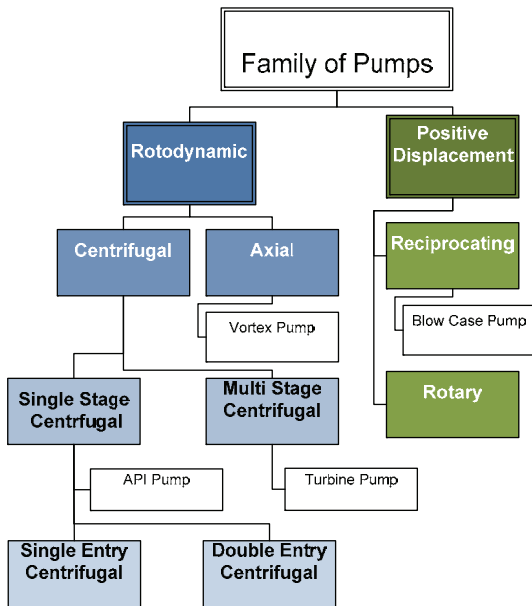

5 Classification of Pumps and Pump Types

Kinetic pumps generate pressure hydrodynamically by using impellers which shift fluid by momentum, rather than positive mechanical travel. They are appropriate for high volume requirements of numerous industrial processes, especially the centrifugal type.

- Single-stage, single-entry pumps are adequate for the lower capacity applications, and for higher duties the single-stage, double-entry type of pump is favoured for its higher efficiency.

In cases where the pressure is required at a higher degree than that of a single-stage centrifugal pump, a two-stage pump using two impellers can be used.

- Pumps with more than two stages are usually referred to as multi-stage pumps.
- In some unique cases for very high pressure requirements, pumps can have more than eight stages. It is common for multi-stage machines to have radially split pump casings.

Positive displacement pumps produce pressure hydrostatically by reciprocating or rotary action.

High-pressure requirements or low-flow duties are best suited to reciprocating pumps. Rotary machines are less suited to developing high pressure due to internal leakage and practical size restrictions.

a. Kinetic Rotodynamic Pumps

Centrifugal Pumps

Centrifugal pumps are the most common type of pump found in industrial environments. Centrifugal pumps are normally sized to deal with the requirements for peak flow, which typically takes place for very short periods of time.

The principal components of a centrifugal pump are:

- Electric motor,
- Impeller,
- Pump casing that houses the impeller, and
- Pump shaft to join the motor to the impeller.

Driven by either atmospheric pressure or fluid pressure upstream from the pump, the fluid enters the pump casing and is directed to the center of the spinning impeller by the casing. A succession of guide vanes on the impeller induces the fluid to the outside of the casing by centrifugal force where it exits through the discharge side of the pump. A vacuum is created at the fluid inlet side, and this causes additional fluid to enter the pump.

Figure 4: Centrifugal Pump



Centrifugal pump performance is generally described by five terms:

- **Capacity** or rate of flow, typically expressed in gallons per minute.
- **Efficiency**, which is the ratio of work performed to power input.
- **Head**, which is the pressure increase of the fluid, expressed in feet.
- **Input power** usually indicated as brake horsepower (BHP).
- **Speed of Rotation** in revolutions per minute.

5 Classification of Pumps and Pump Types

Centrifugal pumps are normally sized to operate at or close to the best efficiency point at greatest flow. In applications where the maximum flow requirements occur during relatively short periods of time through the operating cycle, a method of flow control is required.

The customary approach to controlling the flow rate of pumps uses throttle or bypass valves. As the operation of these valves results in increased pressure produced by the pump, there is an inherent waste of energy, and consequently the pumping system operates at reduced efficiency levels.

Turbine Pump

Turbine pumps are rotodynamic and are characterized by the multiple numbers of vanes that are built into the outside edge of the rotating impeller. With two or more stages, these pumps are capable of producing pressure heads of over 900 feet.

- Turbine pump impellers have very tight axial clearances and use pump channel rings, hence they have very nominal recirculation losses.
- With turbine pumps, liquid entering the channel from the inlet is pulled out right away by the vanes on either side of the impeller. With each successive pass, the process is repeated, and energy is imparted until the liquid is discharged.

Vortex Pump

A vortex pump has a standard concentric casing along with an axial suction intake leading to a tangential discharge nozzle.

5 Classification of Pumps and Pump Types

The rotating impeller creates a vortex field within the casing thereby causing liquid to be pushed towards the tangentially-located discharge. Since the pumped fluid does not have to pass via any vane passages, the particle size of the solid content is limited only by the suction and discharge diameters.

Vortex pumps can handle fluids with high solid contents as well as entrained gases. A vortex pump can deal with much larger percentages of air and entrained gases compared to a standard centrifugal pump. This is due to the pumping action caused by the presence of an induced vortex rather than by impeller vanes.

Vortex pumps, however, have relatively low efficiencies that range from 35% to 55%.

API Pump

Heavy duty centrifugal pumps are required for certain applications in the petroleum, petrochemical and natural gas industries. These pumps are typically designed and manufactured according to API 610, 9th ed. / ISO 13709. This international standard specifies requirements for centrifugal pumps used in the above industries. The standard does not refer to any outline dimensions of the pumps.

- The pump is of back-pull-out design. That means rotating pump unit (including bearing bracket, intermediate casing, shaft sealing and impeller) can be removed without disassembly of the volute casing. Suction and discharge pipe remain connected.

- API pumps usually have a heavy duty bearing bracket to accept all forces imposed upon the pump shaft and maintain rotor position during operation. The pumps are mounted to an API baseplate and are direct coupled to the drivers.

b. Positive Displacement Pumps

Positive Displacement (PD) pumps can be classified into three main groups:

- Rotary,
- Reciprocating, and
- Blow case.

In most instances, the maximum working pressure for a rotary is 360 psi; however other positive displacement pumps are capable of much higher pressure operation. Through the action of rotating screws, PD pumps transfer liquid from suction to discharge.

- Reciprocating pumps discharge liquid by changing the internal volume and typically work at pressures up to 7,000 psi.
- Most reciprocating pumps use pistons, plungers or diaphragms to drive the fluid by displacement.
- They work by displacing a discrete volume of liquid between an inlet valve and a discharge valve.
- The rotary movement of the electric motor is converted to reciprocating motion by a crankshaft.

5 Classification of Pumps and Pump Types

Reciprocating Pumps

Two common types of positive displacement reciprocating pumps are piston/plunger type and diaphragm type.

Reciprocating pumps use a moving piston, plunger or diaphragm to admit liquid into a cavity via an inlet valve. This liquid is then pushed out through a discharge valve by direct application of force, rather than by (centrifugal) acceleration.

Generally, the efficiency range for reciprocating pumps is from 50% to 90%, with the larger capacity units having higher efficiencies.

- Reciprocating pumps are capable of processing a diverse range of liquids, including those with extremely high viscosities, high temperatures and high slurry concentrations.
- For a highly viscous liquid, it is important to ensure that the fluid flows into the pumping chamber so it can be displaced.
- At times it may be necessary to slow the pump to give the viscous liquid time to fill the chamber on each stroke. The head on the viscous liquid must be sufficient to move the liquid into the pump cylinder.

Blow Case Pumps

These are positive displacement pumps having two pressure chambers that are alternately filled with liquid. When the first chamber is filled with fluid, air or steam is introduced into the second chamber.

5 Classification of Pumps and Pump Types

Consequently, the entrained fluid in the first chamber is discharged into the system. By alternating the function of the two chambers in this sequence, a relatively steady discharge pressure and flow can be sustained.

Blow case pumping is suitable for pumping hot condensate because there is no heat loss, and flashing fluid can be transferred.

5 Classification of Pumps and Pump Types

6 UNDERSTANDING THE THEORY OF PUMPS

Pumps are used to transfer a liquid from one point (source) to another (required destination). The pump creates the necessary pressure to overcome losses in the system that is required to cause the liquid flow at the required rate.

For example, pumps can be used for filling a water reservoir, or to circulate liquid around a closed loop system.

System losses

The associated energy losses are of two types:

- Static, and
- Dynamic.

Figure 5: Static and Dynamic Head

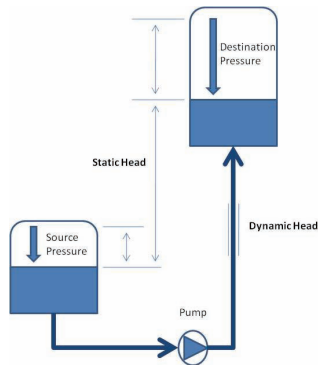

6 Understanding the Theory of Pumps

Most pumping systems have a combination of static and dynamic head. The ratio of static to dynamic head over the operating range can influence the potential benefits achievable from variable speed drives. This is discussed in more detail in the “**Introduction to Adjustable Speed Drives**” section of this Guide.

In simplistic terms, static head is the difference in height of the supply and destination of the liquid being moved, or the pressure in a vessel into which the pump is discharging, if it is independent of flow rate.

- Static head is a characteristic of the specific installation.
- Reducing static head whenever possible generally reduces both the cost of the installation and the cost of pumping the liquid.

Dynamic head loss is proportional to the square of the rate of flow. It is caused by friction and is the energy loss resulting from the liquid being moved through the pumping system, which includes pipes, valves and other components in the system.

- A closed-loop circulating system, without a surface open to atmospheric pressure, would display only friction losses.
- Dynamic head energy losses can be minimized by eliminating unnecessary pipe fittings, turns and constrains, and by reducing the total pipe length and thus help to reduce pumping cost.

6 Understanding the Theory of Pumps

- Larger diameter pipes tend to reduce the dynamic head because of reduced friction; however, they tend to increase the cost of installation.

In order to determine the actual operating conditions of a pump in a given application, it is necessary to have the system characteristic curve. Figure 6 represents the unique characteristics a specific piping system to which a specific pump is applied.

Figure 6: System Curve

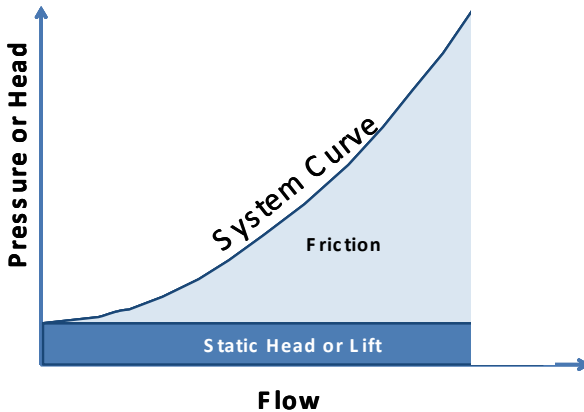

- The head required at zero flow is called the static head.
- This point indicates the number of feet of elevation that the pump must lift the fluid regardless of the flow rate.

6 Understanding the Theory of Pumps

Put in other terms, the static head can be considered to be the amount of work required to overcome the effect of gravity.

- The other component of head is called the dynamic head (**friction head**) and increases with increasing flow.

Dynamic head is a measure of the resistance to flow or backpressure provided by the pipe system and its associated components (elbows, valves and other system elements.)

Pump Curves

Figure 7 shows a pump curve depicting the head (or pressure) versus flow characteristics of a typical centrifugal pump. This curve shows that the pump will produce limited flow if applied to a piping system in which a large pressure differential is required across the pump to lift the liquid and overcome resistance to flow (1). As the required pressure differential is reduced, the flow increases (2).

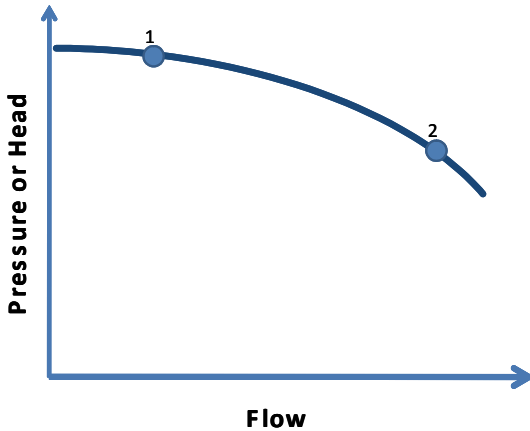
Figure 7: Typical Characteristic Curve for Centrifugal Pump

Pump performance can be shown graphically as head or pressure against flow rate as in Figure 8.

- The rotodynamic pump has a curve where the head falls gradually at a steeper rate as flow increases.
- However, for a PD pump, the flow is almost constant whatever the head.

Figure 8: Performance Curves for Rotodynamic and Positive Displacement Pumps

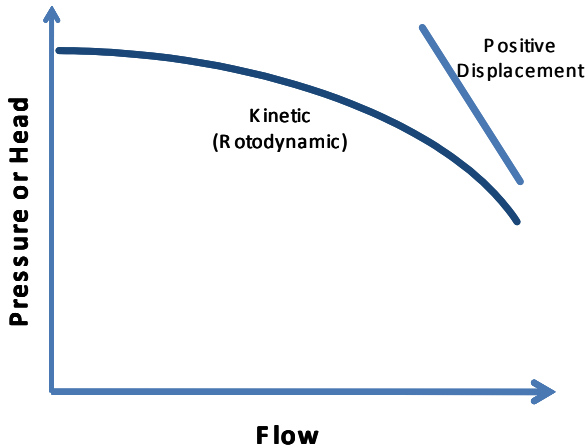

Combined System and Pump Curves

When a pump is installed in a system, the overall effect, including the operating point, can be shown graphically by overlaying the pump and system curves.

The operating point will always be where the two curves intersect.

The meeting point of the pump and system curves shows the operating point for the system with no flow control, as depicted in Figure 9.

The pump selected should have a characteristic curve that, when superimposed on the system curve, has a point of intersection (or “operating point”) that is at or near its “best efficiency point” (BEP).

Figure 9: Combined Pump and System Curves

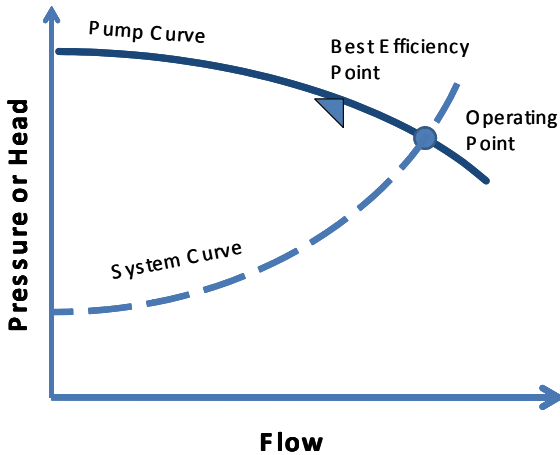

Pump Efficiency Maps

Pump efficiencies at various operating points are readily obtainable from the pump manufacturer in the form of an efficiency map superimposed over the pump curves for various impeller sizes as shown in Figure 10. Pump manufacturers usually offer pumps with different size impellers (but with a common size of casing) in order to offer a wider option of flow rates for each pump model (at a constant speed)

Figure 10: Pump Efficiency and Impeller Diameter

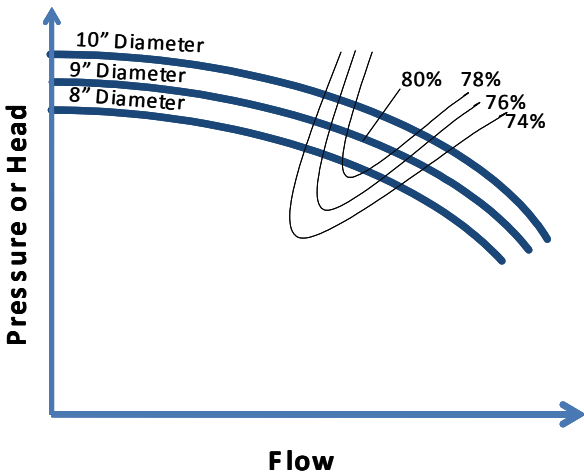

a. Pump Affinity Laws

The variation of pump performance with speed is usually described by the affinity laws, which state that:

- The flow is directly proportional to rotational speed;
- Pressure is proportional to the square of the rotational speed; and
- Power is proportional to the cube of the rotational speed.

The affinity laws can be used to predict the performance of a centrifugal pump having little or no static head. To use the affinity laws, one needs to know the pump's performance at its normal operating point. The affinity law equations for centrifugal pumps are as follows:

6 Understanding the Theory of Pumps

Flow varies directly with pump speed.

$$\text{Flow}_2 \div \text{Flow}_1 = \text{RPM}_2 \div \text{RPM}_1$$

Head or Pressure varies with the square of the pump speed.

$$\text{Head}_2 \div \text{Head}_1 = (\text{RPM}_2 \div \text{RPM}_1)^2$$

Power varies with the cube of the pump speed.

$$\text{Power}_2 \div \text{Power}_1 = (\text{RPM}_2 \div \text{RPM}_1)^3$$

As depicted in Figure 11, the affinity laws illustrate that the pump head decreases considerably as the pump speed is reduced to match system flow requirements.

Figure 11: Centrifugal Pump Capacity as a Function of Pump Speed

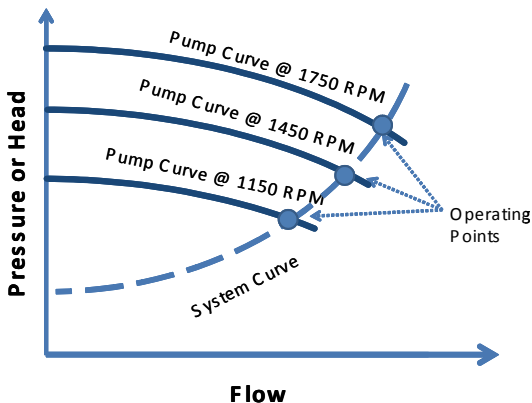

For example at 50% speed, a pump produces 50% of the flow, generates 25% head and consumes only 12.5% power.

6 Understanding the Theory of Pumps

Caution: The affinity laws are sometimes incorrectly applied especially for pumping systems with substantial amounts of static head. For systems where there is no static head component the affinity laws can be used directly to estimate the savings potential of reduced speed operation.

Figure 12 graphically illustrates the physical laws of centrifugal pumping applications.

Flow \propto Speed

Head \propto Speed²

Power absorbed \propto Speed³

Figure 12: Affinity Laws for Centrifugal Pumps

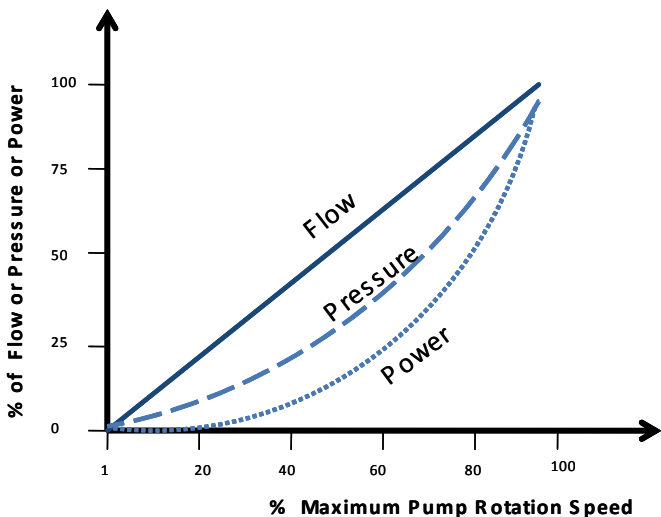

In reality however most pumping systems have some static head component. Hence the affinity relationships must be modified to account for this.

For example, as shown in Figure 13, at 40% of full operating speed, about 40% flow would be produced through the system with no static head; however, no flow (see point “X” in Figure 13) would be produced through the system with static head. The pump speed would have to increase sufficiently to overcome the static head before flow would actually start to increase. The affinity laws would then apply to flow conditions above the static pressure that must be overcome before flow starts.

Figure 13: Varying Pumping Speed with and without Static Head

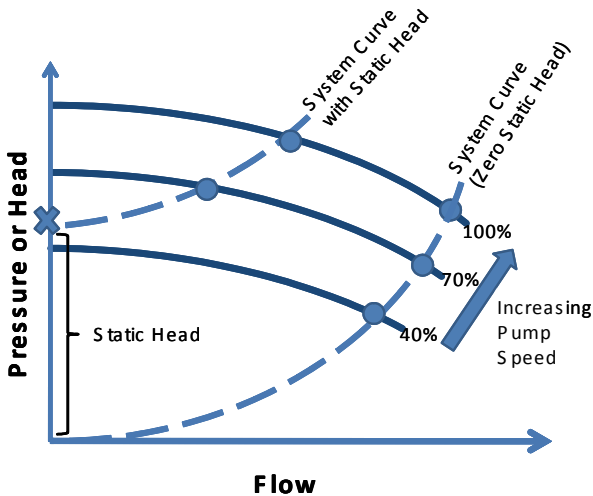

b. Cavitation

A symptom of cavitation usually involves a strongly increased noise level (sounds like marbles) of the pump with a simultaneous reduced flow rate.

Cavitation occurs when bubbles form in the fluid where the pressure of the fluid drops below the vapour pressure of the fluid.

- When the fluid reaches an area of higher pressure, the bubbles collapse and the resulting shock waves create excessive noise, reduce the efficiency of the pump and can actually damage the pump's impeller, seal and/or bearings.
- The lowest pressure point in a pump occurs at the inlet of the pump impeller.
- Some of the fluid may evaporate generating small vapour bubbles, which are eventually carried along by the fluid, where they implode instantly when they get into areas of higher pressure.
- The vapour pressure of the fluid is dependent on the temperature and will rise with increasing temperature. If the fluid is pumped at different temperatures the maximum vapour pressure should be used to determine the “net positive suction head” (**NPSH**) value of the plant.

The two main conditions for cavitation include:

- **Net Positive Suction Head Required (NPSH_r) Exceeds Net Positive Suction Head Available (NPSH_a).** Due to low pressure the water vaporizes (boils) and higher pressure implodes into the vapour bubbles as they pass through the pump diminishing the performance and leading to potentially major damage.
- **Suction or discharge recirculation.** Pumps are designed for a certain flow range. In situations where there is insufficient flow going through the pump, the resulting turbulence and vortices can reduce performance and damage the pump.

Operation under cavitating conditions over extended periods of operation usually results in premature wear or damage to the impeller, the pump housing and cover, as illustrated in Figure 14. The surfaces are usually damaged by perforations and pitting.

To prevent cavitation, it is essential that the fluid pressure be higher than the vapour pressure in all points of the pump, at all operating temperatures.

6 Understanding the Theory of Pumps

Figure 14: Extreme Example of Impeller Cavitation and Corrosion (Photo courtesy of the Association for Iron & Steel Technology)



7 PUMP CONTROLS

For operations that require variations in flow over short or extended periods, there are four primary methods for controlling flow through a pumping system or its individual branches. They are:

- Throttle valves,
- Bypass valves,
- Pump speed control, and
- Multiple pump arrangements.

The most energy efficient method of pump control depends on the situation.

The selection of the most appropriate pump flow control method depends on:

- Fluid properties,
- Sensitivity of the process to flow rate changes,
- Shape of the pump power curve
- System layout,
- System flow/pressure requirements over time, and
- System size.

a. Throttle Valves

- A throttle valve chokes fluid flow so that less fluid moves through the valve, creating a pressure drop across the valve, which increases the pressure against which the pump must now operate.

7 Pump Controls

- Throttling is usually applied by using a valve on the outlet of a pump to vary the flow.

Throttling is a very common and effective technique to reduce flow from pumps; however, it is not an energy efficient technique since energy is wasted across the throttle.

- Although the desired reduction in flow is attained, it comes at the cost of increased system pressure relative to 100% flow.

As depicted in Figure 15, throttling is commonly employed as a flow setting or controlling technique. Note: Static Head is present in most pumping situations, but for illustrative purposes, it is not shown in Figure 15.

Figure 15: Throttled and Unthrottled Pump Control

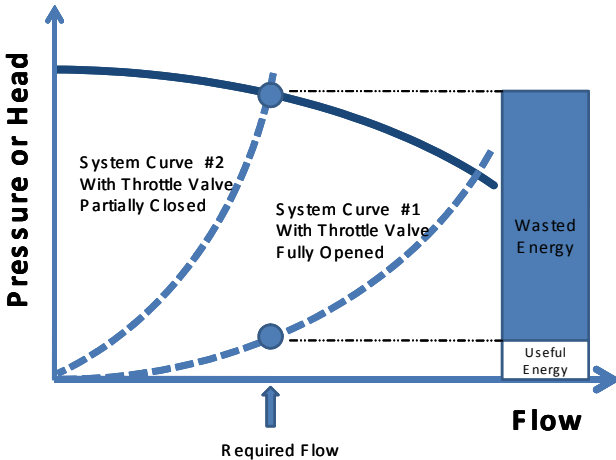

b. Bypass Valves

A bypass valve allows flow to go around a system component by increasing or decreasing the flow resistance in a bypass line.

A key drawback of bypass valves is their unfavorable impact on system efficiency. The power used to pump the bypassed fluid is wasted.

- In configurations with large amounts of static head, bypass valves could be more efficient than throttle valves or systems with adjustable speed drives (ASDs).

Figure 16 shows a pump curve with bypass control. This configuration allows for control over a wide range of flows.

Figure 16: Pump Flow Range with Bypass Control

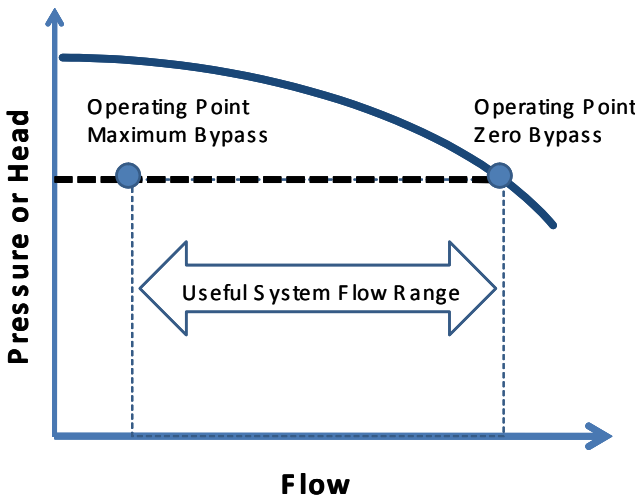

c. Pump Speed Control

When a pump's speed is reduced, less energy is imparted to the fluid and less energy needs to be throttled or bypassed. Speed can be controlled in a number of ways; the most popular type is the variable speed drive on the motor.

- For any given liquid, the power that the pump must transfer to the liquid is proportional to the head times the flow.
- This amount of power can be represented by rectangles for each operating point as shown in Figure 17.

Figure 17: Saving Energy by Using Pump Speed Control

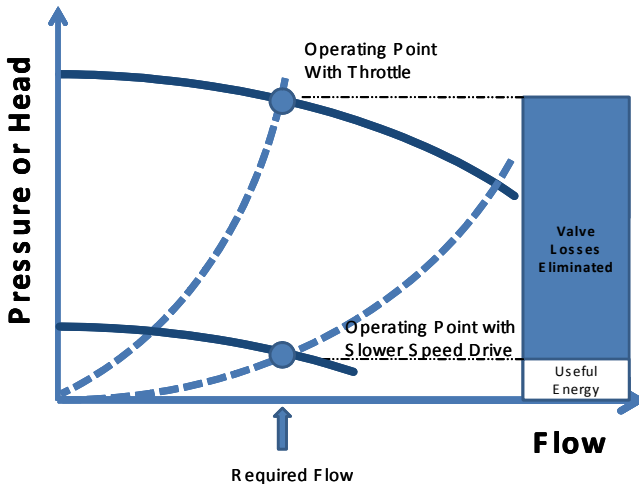

- This figure illustrates a substantial reduction in output power caused by the use of slower speed drive rather than throttle valve control.
- The energy saving potential available at this particular flow point is represented by the darker rectangle.

Figure 15 shows what happens to an operating point when a system is throttled. In essence, the System Curve shifts to the left and becomes steeper, as the system resistance increases as the throttle valve is closed. This is shown by the transition from System Curve #1 to System Curve #2.

An initial step toward achieving energy savings on centrifugal pumping applications is the decision to evaluate ASDs where applicable.

- The next step is to utilize the most efficient adjustable speed drive that meets the application requirements.

Solid-state ASD devices have much lower losses than mechanical slip devices at lower operating speeds.

- Pumps should normally be operated within a flow range near the peak pump efficiency flow.
- The range over which throttling should be employed is limited to avoid flow related problems and attain peak efficiency.

As most industrial pumps are over-designed, they generally operate below the best efficiency point (BEP), and are unable to achieve maximum efficiency.

7 Pump Controls

- Notwithstanding the pump using less power than it would at full flow, energy is nevertheless being wasted.

Pump speed control is mainly appropriate for systems where friction (rather than static) head predominates.

Pump speed can be controlled by mechanical means or by electrical means to match the speed of the pump to the flow and pressure demands of the system. A pump can be operated at low speeds during periods of low system demand and at full speed at other times of high system demand

- Mechanical means include belt drives with sheaves and pulleys offering various ratios between a (nearly) constant speed induction motor and slip drives (not very efficient).
- Electrical means include multiple-speed induction motors with 2, 4, 6 or more poles that can be operated efficiently at full, half or third speed and “adjustable speed drives” (ASDs) that offer smooth rather than stepped speed control over the full range of speeds.

The main differences between multiple-speed motors and ASDs are the degree of speed control available from each system and that the efficiency of an electric motor controlled by an ASD drive drops off as it is operated at loads near 50% or less over long periods of time. One must carefully evaluate the net savings possible through the application of an ASD, taking into account total capital cost and estimated savings over the life of the control. Figure 17 shows the energy savings potential from using pump speed control compared to throttle control. Note: Static head is present in most pumping

situations, but for illustrative purposes, it is not been shown in Figure 17.

d. Multiple Pump Configurations

This control method uses multiple pumps connected in parallel in any of the following configurations (appropriate plumbing, valves and controls are required):

- **“Either or”**: in this situation, a large pump is connected in parallel with a small pump (**“pony pump”**). Either the pony pump operates (during normal conditions) or the large pump operates (during high flow conditions). This configuration is often used for municipal water and wastewater pumping facilities.
- **“Two identical pumps”** connected in parallel with piping and valves that permit one pump to operate alone or both pumps to operate simultaneously to provide two different levels of flow efficiently. This arrangement is usually much more efficient than operating one large pump at half output over long periods of time.
- **“Three or more”** identical pumps connected in parallel with appropriate plumbing and valves can be operated efficiently by opening valves and turning on the most appropriate number of pumps to produce the required flow rates. For example, large municipal water supply pumps are operated in this way. In these situations, one pump is usually provided with speed control to provide variable flow to permit continuously matching supply pumping power to maintain the

7 Pump Controls

required constant pressure as the demand of the system varies.

As only the required number of pumps operates at their best efficiency point (BEP), the overall system operates more efficiently than the case of operating one large pump far away from its BEP.

e. Pump Output Power

The pump's output power, or hydraulic power, can be expressed as:

$$\text{Hydraulic Horsepower} \\ = [(\text{Head (feet)} \times \text{Flow (USGPM)} \times \text{Specific Gravity})] / 3960$$

Example 1 - Impact of Changing Fluid's Specific Gravity

A pump curve for a 25 HP centrifugal pump is based on water, with a specific gravity of 1.0, a flow rate of 120 USGPM and head of 73.0 feet. The pump is being considered as a brine pump in a skating arena. The brine solution has a specific gravity of 1.21. Calculate the revised pump head with the brine solution. Assume that the horsepower and flow rates are the same in both cases.

The hydraulic power equation can be simplified as:

$$\text{Head}_{\text{new}} = (\text{Head}_{\text{design}} \times \text{Specific Gravity}_{\text{design}}) \div \text{Specific Gravity}_{\text{new}} \\ = 73 \text{ feet} \times 1.0 \div 1.21 \\ = 60.3 \text{ feet}$$

With the brine solution, the pump's head is 60.3 feet at 120 USGPM flow.

8 INTRODUCTION TO ADJUSTABLE SPEED DRIVES

For pumping applications with variable flow rate requirements, **Adjustable Speed Drives** (ASDs) are an efficient control option compared to throttling or bypass methods.

Consequently the pump can run at various flow rates to closely match the demand of the system.

ASDs can achieve reduced flow by providing variable speed pump operation. Precise speed control can result in reduced overall system pressure and improved operation near the pump's **Best Efficiency Point** (BEP).

ASDs do not save energy in applications that operate at points near full load most of the time. Also, in applications where the pump operates at low speeds most of the time, the efficiency of the motor also drops and other alternative control methods may be more economical.

- ASDs are sometimes not cost-effective in fluid transfer pumping systems where the static head is a significant portion of the total head. In these applications, they usually operate with a narrow control band resulting in modest energy savings.

In an ideal world, ASDs are suited for variable torque centrifugal pumps loads where the system load requirements (flow, head or both) fluctuate with time. Ideal situations that tend to make ASDs most cost-effective include the following:

- **High pump horsepower (greater than 15 HP).** The higher the pump horsepower, the more cost-effective the ASD application.
- **High utility rates.** The higher the utility energy cost, the quicker the payback on the investment for an ASD.
- **Variable load type.** Centrifugal loads with variable torque requirements have the greatest potential for energy savings. Although in some cases ASDs can be cost-effective with positive displacement pumps, the energy savings will generally not be as great as with centrifugal pump loads.
- **Low static head.** ASDs are best suited for circulating pumping systems where the system curve is defined by dynamic or friction head losses. ASDs can also be effective in systems with measurable static head; however, the pump needs to be carefully selected. The design must incorporate a thorough understanding of pump and system interactions in such applications.
- **High operating hours.** ASDs are generally cost-effective only for pumps that operate for at least 2,000 hours per year.

The newest pump-specific adjustable speed drives are able to be programmed with a mathematical representation of the pump curve that it is driving. A torque-control scheme may be used effectively where speed control allows only a narrow control band. For example, in a high static lift situation where the difference between maximum and average flow is only 2%

of full speed, the torque range could be 12% of full torque allowing finer control. The ASDs could also be used to show flow, pressure, efficiency, cavitation, alarm programs and other pump curve specific parameters, either locally or on a process control system.

When evaluating the potential for ASDs, a first step is to develop a system curve. This step is normally followed by matching the characteristics of a candidate pump curve to the system curve at various flow rates.

The system load-duty cycle is a frequency distribution representing the percentage of time that a pump operates at each system operating point. It should be noted that measurements involving or decisions taken related to the load-duty cycle should be made only when it is confirmed that the pump is neither oversized nor undersized for the task at hand.

The system load duty cycle can be helpful to calculate potential energy savings. It can be determined by using historical measurements of fluid flow rates or using a power meter that tracks and records the electrical power input to the pump motor.

Example 2- Energy Savings with Adjustable Speed Drives

Figure 18 represents field data of a load-duty cycle for a pump that operates 7,500 hours per year. In this example static head on the pump is negligible and the pump is driven by a typical 50 HP, 1,800 rpm, fan-cooled standard efficiency motor.

Figure 18: Load-Duty Cycle for an Existing Centrifugal Pump with Throttle Valve Control

Operating Point	Operating Time (hours)	Flow Rate (USGPM)	Head (feet)	Pump Efficiency (%)	Power (bhp)	Duty Cycle (%)
A	2,200	1,200	120.0	80.0	45	29.3%
B	1,800	1,000	134.0	82.5	41	24.0%
C	1,200	800	145.0	82.0	36	16.0%
D	1,200	600	155.0	76.0	31	16.0%
E	1,100	400	160.0	63.0	25	14.7%
Total Hours	7,500					

After establishing values for flow rate and head, the pump efficiency and shaft horsepower required from the manufacturer's pump curve can be determined. By using weighted averages for power at each operating point, and correcting for the motor's efficiency, the weighted input power can be determined as shown in Figure 19.

Figure 19: Power Requirements for a Centrifugal Pump with Throttle Control

Operating Point	Flow Rate (USGPM)	Duty Cycle (%)	Shaft Power (HP)	Drive Efficiency (%)	Motor Efficiency (%)	Weighted Electricity Input (kW)
A	1,200	29.3%	45.00	13.20	91.4	10.77
B	1,000	24.0%	41.00	9.84	91.6	8.01
C	800	16.0%	36.00	5.76	91.6	4.69
D	600	16.0%	31.00	4.96	91.2	4.06
E	400	14.7%	25.00	3.67	90.9	3.01
Total Weighted Input						30.54

By undertaking a similar calculation, the average input power for the same pump with ASD control can be determined, as shown in Figure 20. Pump shaft horsepower requirements at each flow rate can be determined using the affinity law equations in conjunction with the system curve. The motor and drive efficiency needs to be factored for each operating point to calculate weighted input power.

Figure 20: Power Requirements for a Centrifugal Pump with ASD Flow Rate Control

Operating Point	Flow Rate (USGPM)	Duty Cycle (%)	Shaft Power (HP)	Drive Efficiency (%)	Motor Efficiency (%)	Weighted Electricity Input (kW)
A	1,200	29.3%	45.00	95.9	91.4	11.23
B	1,000	24.0%	26.04	94.9	90.9	5.40
C	800	16.0%	13.33	92.1	84.5	2.04
D	600	16.0%	5.62	85.5	70.3	1.12
E	400	14.7%	1.67	53.7	41.1	0.83
Total Weighted Input						20.63

From this example, it can be seen that the average electricity demand savings are 9.91 kW (i.e. 30.54 kW – 20.63 kW). The ASD control versus a throttle control represents an average demand reduction of about 32% for this example.

a. Adjustable Speed Drive Operating Considerations

Some considerations when evaluating the potential for using ASDs include:

- Some ASDs can be programmed to avoid resonance frequencies and some come with an automatic across-the-line bypass in case of failure.
- Install a manual bypass to enable the motor to operate at a fixed speed in case the ASD fails.
- For certain parallel and series pump configurations, consider installing a single ASD to control multiple pump motors.
- Factor in the lag time and use care when dropping the flow velocities of slurries.

Be aware of equipment vibration points and program the drive controllers to avoid operating pumps at speeds which could result in equipment or systems resonances.

9 PARALLEL & SERIES OPERATION

a. Pumps Connected in Series

In series applications, it is necessary to evaluate the pressure rating of pump, shaft seal, piping and fittings. The geometric arrangement of the pumps is important to ensure that both pumps are working within their recommended range.

Plotting a curve for 2 or more pumps can be accomplished by adding the head for each pump, where the flow stays the same. For 3 or more pumps in series, other curves can be derived in the same way.

In summary, when the outlet of one pump is connected to the inlet of a second pump, the approximate combined head/flow characteristic is obtained by adding the heads at each flow value, as illustrated in Figure 21.

Figure 21: Pumps in Series

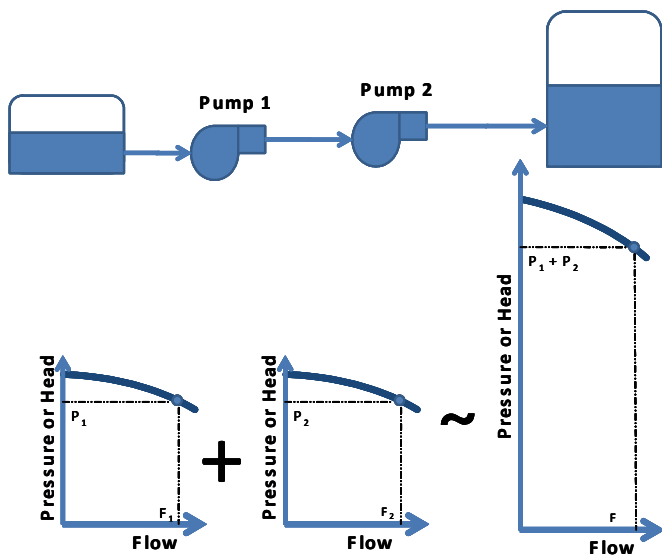

b. Pumps Connected in Parallel

For parallel pumping applications it is important to verify the suitability of pumps by drawing a system curve as shown in Figure 22. It is also important to verify that the pump operation will be within its recommended range.

Figure 22: Pumps in Parallel

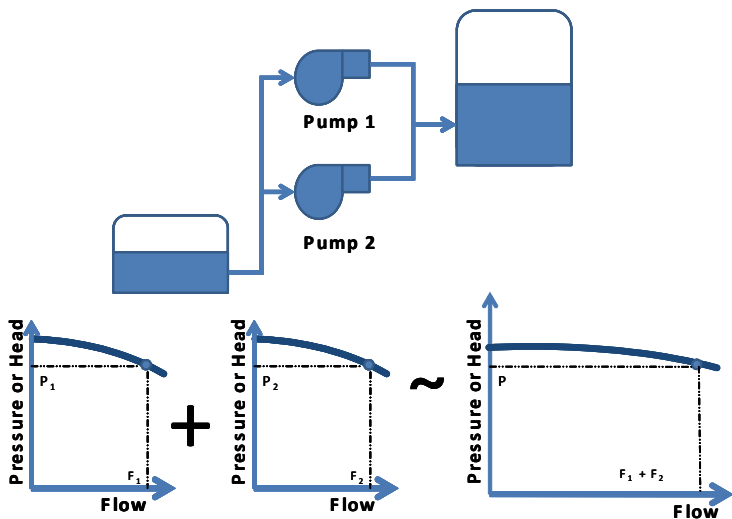

- If two or more pumps are connected in parallel in such a way that their inputs feed from a common main and their outputs lead to a common main, then the resulting characteristic curve can be derived by adding the flows at each head value.
- Even if they are dissimilar sizes, this calculation method applies for any number of pumps connected in parallel.
- Different pumps or pumps positioned at different heights require special investigation.

9 Parallel & Series Operation

- By plotting a curve for 2 or more pumps and adding the individual flows, it can be seen that each pump delivers the same head. Additional compound pump curves can be derived the same way by adding the individual flows.

Note that the flow does not necessarily double on addition of a second similar pump in parallel. Although the total flow is split equally between the pumps, each successive pump adds a smaller amount to the total head and flow.

10 OPERATIONAL AND SYSTEMS CONSIDERATIONS

a. Energy Optimization - Where to Start

- A survey of the pumps at an industrial location involves first assembling pump and drive motor nameplate information.
- It also involves itemizing the operating schedule for each piece of equipment to permit development of load profiles.
- Gathering pump performance curves from manufacturers will help to identify the original and optimal operating points.
- The team should also note the system flow rate and pressure requirements, pump style, operating speed, number of stages and specific gravity of the fluid being pumped.

Where possible, try to measure and note flow rates, suction and discharge pressures and make a note of conditions that are linked with inefficient pump operation, including indicators such as:

- Pumps with poor reliability and/or high maintenance costs.
- Alterations in the distribution system such as cross-connections, parallel main lines or changes in pipe diameter or material which may have affected the original system curve.

- Changes to the pump or system from original design.
- Low-flow rate, high-pressure end-use applications.
- Noise given off by pumps or valves implying bearing problems, drive belt maintenance problems, wear or other mechanical problems.
- Oversized pumps that run in a throttled condition.
- Pumping systems with bypass flows or throttle control valves to provide fixed or variable flow rates.
- Pumping systems with large variations in flow rate or pressure.
- Congested or clogged pipelines or pumps.
- Multiple pump systems where excess capacity is bypassed or excess pressure is created.
- Presence of noise associated with cavitation or maintenance history of badly worn out pumps or eroded components.

b. Pumping System Efficiency Measures

Measures to improve pumping plant efficiency include:

- Meet variable flow rate requirements with an adjustable speed drive or multiple pump arrangement instead of throttling or bypassing excess flow.
- Replace or downsize oversized pumps by installing new, properly sized pumps, or by trimming pump impellers to match the output with system requirements.
- Replace standard efficiency pump drive motors with high efficiency or premium motors.
- Restore internal pump component clearances.
- Shut down unnecessary pumps.

c. High Efficiency Motors

By replacing a standard motor with a high efficiency model, energy savings in the range of 5-10% are common. High efficiency motors are particularly suited for applications having long operating hours. Please see the **CEATI Electric Motors Energy Efficiency Reference Guide** for additional information about high efficiency motors.

To help with screening the economics of switching to high efficiency motors, calculate the annual energy use for both the standard and high efficiency motors, and then assess the cost and payback.

Annual Energy Use (kWh) =

$$[(\text{Motor Nameplate (HP)} \times 0.746 \times \text{Annual Operating Hours (hours)})] \div (\text{Motor Efficiency}(\%))$$

Example 3 – Impact of Installing High Efficiency Motor

A skating rink has a 25 HP brine pump motor that runs continuously from mid-September to mid-April each year (210 days per year). The existing motor has an efficiency of 88.0%. A major refurbishment of the rink is scheduled for next summer, and a high efficiency 25 HP motor (93.6%) is available at a cost of \$1800. The motor is rated at 1800 rpm and supplied with 575 volt three phase power at a cost of \$0.10/kWh. For the purpose of the example assume that the power factor, pump performance and motor speed are the same in both cases.

$$\begin{aligned} \text{Existing Case kWh} &= (25 \text{ HP} \times .746 \times 210 \text{ days} \times 24 \text{ hours/day}) \div 0.880 \\ &= 106,800 \text{ kWh} \end{aligned}$$

10 Operational & System Considerations

$$\begin{aligned}\text{High Efficiency Motor} &= (25 \text{ HP} \times .746 \times 210 \text{ days} \times 24 \text{ hours/day}) \div 0.936 \\ &= 100,400 \text{ kWh}\end{aligned}$$

$$\begin{aligned}\text{Annual Energy Savings} &= 106,800 \text{ kWh} - 100,400 \text{ kWh} \\ &= 6,400 \text{ kWh}\end{aligned}$$

$$\begin{aligned}\text{Annual Cost Savings} &= 6,400 \text{ kWh} \times \$0.10/\text{kWh} \\ &= \$640.00\end{aligned}$$

$$\text{Simple Payback} = 2.8 \text{ years}$$

d. Optimized Pipe Diameter Sizing

- The power consumed to overcome the static head in a pumping system varies linearly with flow.

Generally, little can be done to decrease the static head component of the system requirement, unless the equipment can be more favourably relocated.

- On the other hand, the power required to overcome the frictional or dynamic pressure component depends on flow rate, pipe diameter size, overall pipe length, composition of fluid being pumped and pipe characteristics such as material and surface roughness.

Figure 23 shows the annual water pumping cost (frictional power only) for 1,000 feet of pipe length for different pipe diameter sizes and flow rates.

Figure 23: Annual Water Pumping per 1,000 Feet of Piping by Pipe Diameter Size

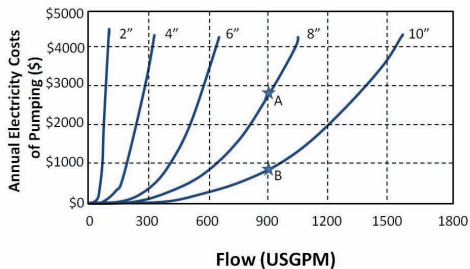

Basis: Water @ 70°F, Power Cost \$0.10/kWh, Operating Hours 8760/year

Adapted from "Reduce Pumping Costs through Optimum Pipe Sizing" US Department of Energy 1999

Example 4 - Calculation the Energy Impact of Changing Pipe Diameters

For example (using Figure 23), the operational cost for 900 USGPM flow using a 8 inch diameter pipe is about \$2,900 (point A) per year, whereas by using a 10 inch diameter pipe, this drops to about \$900 (point B). The incremental cost of selecting larger pipe diameter sizes needs to be factored into the evaluation.

e. Optimizing Control Valves

Throttling control valves are inherently inefficient and usually provide opportunities for energy savings and reduced maintenance costs of pump systems.

Throttling valves can contribute a large portion to the pressure drops or head losses in liquid pumping systems thereby increasing the energy requirements of these systems.

10 Operational & System Considerations

- Pumping system controls need to be evaluated to establish the most economical and practical control method.
- It is common to find components with high head losses, such as globe valves, being used for control purposes instead of gate valves or ball valves with much lower losses.
- Pressure drops are caused by resistance or friction in piping, elbow bends, joints and also from the throttling action across control valves. If the assessment shows that a control valve is required, select the type that minimizes pressure drop across the valve.

64 The extra power necessary to overcome a pressure drop is proportional to the fluid flow rate (USGPM) as well as the degree of the pressure drop (feet).

$$\text{Fluid Horsepower} = [(\text{Flow Rate (GPM)} \times \text{Head Loss (feet)} \times \text{Specific Gravity})] \div 3960$$

- For water, where the specific gravity is 1.0, a pressure drop of one pound per square inch (psi) is equal to a head loss of 2.308 feet.
- Friction losses and pressure drop caused by fluids flowing through valves and fittings depend on the pipe diameter, pipe length, type of pipe and fittings used.

In addition, the roughness of interior surfaces, rate of fluid flow and fluid viscosity all influence the friction losses.

$$H_f = K \times V^2 \div (2 \times g)$$

Where:

H_f = the fitting head loss, in feet

V = fluid flow velocity, in feet/second

g = the gravitational acceleration constant, 32.2 feet per second per second

K = the fitting head loss coefficient.

For valves, K is a function of valve type, size and the percentage of time that the valve is open.

Figure 24 shows the Head Loss Coefficients (K) for typical valves and components found in pumping systems. Values can diverge by 30% to 50% due to variations in pipe dimensions, type of fluid and other factors.

Figure 24: Range of Head-loss Coefficients (K) for Water Flowing through Various Fittings

Fitting Description	K Value
Gate valve	0.03 – 0.2
Ball valve	0.04 – 0.11
Bell-mouth inlet	0.05
Long radius elbow	0.1 – 0.3
Standard elbow	0.2 – 0.3
Butterfly valve	0.5 – 2
Check valve	2
Globe valve	3 – 12

f. Pump Wear and Tear

For water pumps, the major causes of pump wear revolve around poor water quality.

10 Operational & System Considerations

- Common problems are caused by high concentrations of particulates and low pH values which lead to wear through erosion and corrosion.
- In most cases, filtration and water treatment can be used as an effective deterrent although there will always be some degree of corrosion and erosion.

g. Pump Instability and Drooping

Some pumps have performance curves that droop at low flow rates. This is especially true in the case of pumps primarily operating with low specific speeds. Figure 25 is a representative diagram (not an actual pump curve) that shows the pump and system curves.

Figure 25: Drooping Pump Performance Curve

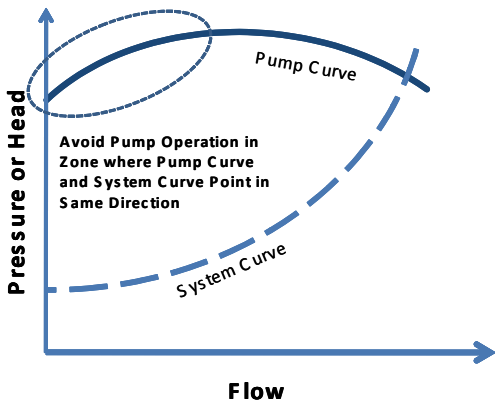

The droop of pump pressure at low flow rates indicates that under low flow conditions, the pump and system will interact;

as a result, the pump will hunt between a lower and a higher load, causing the equipment to load up and unload repeatedly, and resulting in excessive wear and a continuously varying flow rate.

In the low flow rate zone, both curves are sloped upwards, with the possibility of intersecting at more than one point. This could lead to operating instability, and hence should be evaluated carefully especially for multi-speed and ASD drives.

11 ENERGY SAVINGS AND ECONOMICS

One consideration from an economics standpoint is oversizing the pump. Frequently, purchasers of a pump will augment the required flow rate by a margin to ensure that the existing pump will be able to handle future increases to the system's output requirements.

- The difference in energy cost may prove to be less expensive in the long run if a smaller pump is installed first, and eventually is replaced it by a larger pump or is supplemented by adding a second pump in parallel when needed.

The best practice of pump selection would be to choose a pump with a BEP within 20% (of the flow) of the intersection of the pump and system curves. Common practice is to purchase a spare “full size” impeller so that it will be either ready for full pressure/flow capability or trimmed to suit. It would also be ready to fit any other pump of that model/size.

69

Example 5 - Pump Selection

A plastics company with two shifts has 20 water-cooled injection machines, which collectively require 2,100 USGPM at a total operating head of 125 feet. Assume that the pump is powered by a 94% efficient 70 HP motor, operates for 4,300 hours per year, the cost of power is \$0.10/kWh and that the specific gravity of the water is 1.0. The pump needs to be replaced and two quotes have been procured. The first quote is

11 Energy Savings and Economics

for a pump with 76% (η_{base}) efficiency. The second quote is for \$1300 more, but offers a pump with 82% ($\eta_{\text{efficient}}$) efficiency.

Power Differential (kW)

$$= [(\text{Head} \times \text{Flow} \times \text{Specific Gravity} \times 0.746) \div (3960 \times \text{motor efficiency})] \times [(1/\eta_{\text{efficient}} - 1/\eta_{\text{base}})]$$

Power Differential

$$= [(125 \text{ feet} \times 2,100 \text{ USGPM} \times 1.0 \times 0.746) / (3960 \times 0.94)] \times (1/.82 - 1/.76)$$
$$= 5.1 \text{ kW}$$

Energy Cost Savings

$$= 5.1 \text{ kW} \times 4,300 \text{ hrs/year} \times \$0.10/\text{kWh}$$
$$= \$2,190$$

The energy savings are expected to be \$2,190 per year

The simple payback period to procure the higher efficiency pump is $\$1,300 \div \$2,190$
= 0.59 years about 7 months.

Over a projected 15 year pump life, the expected energy savings will be \$32,800 (current dollars).

Remember to also factor in the importance and influence of properly sized pipes.

- Once a pump is purchased and installed, it should be operated and maintained to ensure that the pump continues to perform its job as close as possible to its BEP.

a. System Optimization and Retrofits

- Friction losses on the suction side can also be reduced by moving the pump closer to the supply reservoir.
- Since more efficient pumps generally have a higher first-time cost, doing a life cycle cost analysis for different types of pumps can be beneficial. Multistage pumps are usually more efficient than single-stage pumps; however, their first-time cost is higher.
- Remember that running a pump at a higher speed is usually more energy efficient, but the higher speed pump may have to be aligned more precisely and may require more maintenance.
- The clearances of the impeller and of the wear ring should be checked and adjusted as often as feasible to minimize leakage (recirculation loss) from the discharge side of the impeller to the suction side.
- Avoid operating a pump at a higher flow rate than necessary, as the higher the flow rate, the more energy is consumed.
- Consider installing multiple pumps in parallel to provide greater flexibility in flow rates.

12 HOW TO OPTIMIZE PUMP SYSTEMS

When investigating pump trouble, every effort must first be made to eliminate all outside influences.

If the performance of a pump system is suspect, the correct use and accuracy of instruments should first be checked.

- Pump performance is substantially affected by such liquid characteristics as temperature, specific gravity and viscosity.

a. Pump Optimization Prioritization

Pump optimization at most industrial locations follows the Pareto Principle or 20:80 rule. In essence, about 80 percent of the energy savings will come from optimizing 20 percent of the pumps. Initially, it is important to focus on pump system improvements that may result in the fastest energy savings and quickest operating and maintenance cost reductions.

Figure 26 outlines a suggested method to prioritize the 20% of pumps most likely to result in 80% of the energy savings.

Figure 26: Pump Prioritization Flowchart

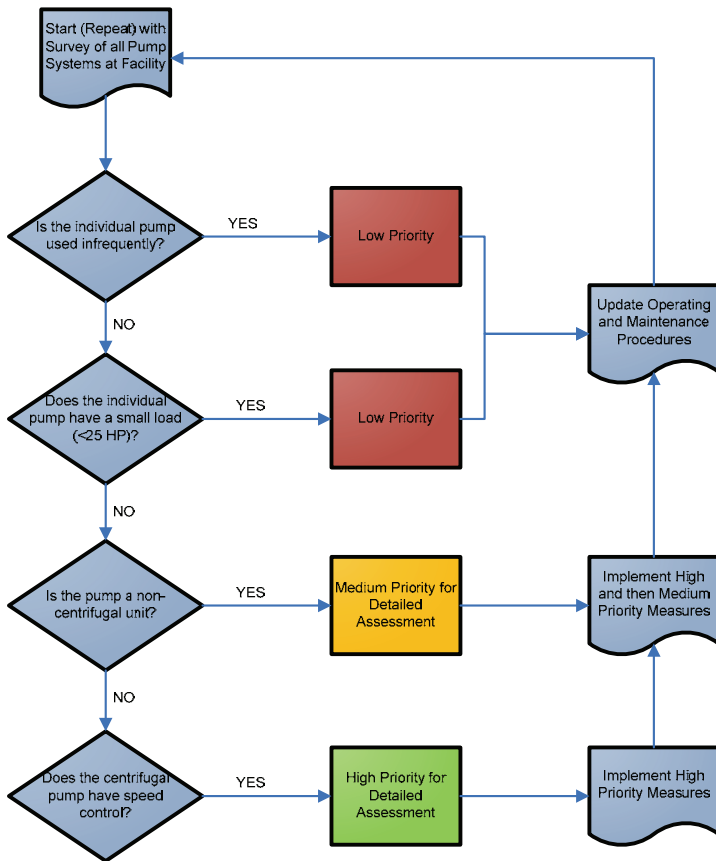

b. Practical Tips for Pump Optimization

The system point of operation is the intersection between the system resistance curve and the pump performance curve. This system point determines the flow rate. The two main ways to change the point of operation are:

- Change the characteristics of the turbo machine performance curve, varying speed, changing inlet vane settings, and
- Modify the system curve by changing system losses or flow.

A standard pump optimization methodology would encompass the following steps:

- **Determine the required pump capacity.** The first step in selecting a pump is to determine the required capacity of the pump. This will also be influenced by the intended application of the pump.
- **Determine the required total dynamic head of the pump from the system head.** The second step is to specify the required total dynamic head of the pump. This is determined by the system in which the pump will be installed and is equal to the **total system head**. All four system head loss terms are added together to determine the total system head loss which will equal the total dynamic head of the pump. The total system head is the sum of:
 - **Friction Head (H_f)** - the force required to overcome the internal friction of the piping system.

12 How to Optimize Pump Systems

- **Pressure Head (H_p)** - the difference in pressure between the fluid supply reservoir and the fluid delivery reservoir.
 - **Static Head (H_s)** - the change in elevation (in feet) that the fluid undergoes in the system without regard to the location of the pump.
 - **Velocity Head (H_v)** - the change in head of the fluid due to the change in velocity through the pump.
-
- **Check pump manufacturers' selections to choose a standard pump and speed.**
 - **Determine the efficiency and the required horsepower of the pump.** The required impeller diameter, pump efficiency, required horsepower and $NPSH_r$ can be determined from the specific curve.
 - **Compare various standard pumps and speeds to determine the most efficient pump.** The horsepower requirements for the various pumps and speeds can be compared to determine which pump or speed will be the most energy efficient.
 - **Compare Net Positive Suction Head Available ($NPSH_a$) with Net Positive Suction Head Required ($NPSH_r$) to ensure that cavitation will not occur.** Following selection of the most efficient pump, the $NPSH_a$ should be calculated to verify that it is greater than the $NPSH_r$.

c. Identifying Inefficient Pumps

Pumps are often considerably larger than they need to be for an industrial plant's process needs. Centrifugal pumps are often oversized because of:

- Anticipating future plant capacity expansions,
- Attempting to have room for gradual increases in pipe surface roughness and flow resistance over time, and
- Rounding up to next available size.

In addition, the plant's pumping requirements might not have been clearly defined during the design phase.

- Because of this conservative approach, pumps often have operating points completely different from their design points.
- The pump head is often less than expected, while the flow rate is greater. This can cause cavitation and waste energy as the flow rate typically must be regulated with bypass or throttle controls.

d. Matching Pump to Motor

Conventional practice in motor selection is to choose one size larger than what is sufficient to meet the power requirement at the right-hand end of the pump characteristic curve.

- In most cases, this operating condition is never encountered, and the oversized motor operates at a lower than optimum efficiency and the pump (which

12 How to Optimize Pump Systems

is throttled) operates below the BEP and supplies the loss across the throttling valve.

Motors and pumps should be optimally selected to meet the specified flow and head requirements.

e. Trimming Impellers

Pump and system curves can provide the efficiency or shaft power for a trimmed impeller.

For product standardization purposes, pump casings and shafts are built to be capable of using impellers in a range of sizes. Pump manufacturers generally provide pump performance curves that show how specific models will perform with different impeller diameters or impeller “trims.”

If these curves are not available, affinity laws can be used to predict the variations in pumping performance with changes in the impeller diameter:

$$\begin{aligned} \text{Flow}_1 \div \text{Flow}_2 &= \text{Impeller Diameter}_1 \div \text{Impeller Diameter}_2 \\ \text{Head}_1 \div \text{Head}_2 &= [\text{Impeller Diameter}_1 \div \text{Impeller Diameter}_2]^2 \\ \text{Brake HP}_1 \text{ Brake HP}_2 &= [\text{Impeller Diameter}_1 \div \text{Impeller Diameter}_2]^3 \\ &= [\text{Head}_1 \times \text{Flow}_1 \div \text{Head}_2 \times \text{Flow}_2]^3 \end{aligned}$$

Oversized and throttled pumps that produce excess pressure are exceptional candidates to save energy and reduce costs via impeller replacement or “**trimming**.”

- Trimming involves machining the impeller to reduce its diameter. A smaller or trimmed impeller can be

used efficiently in situations where the current impeller is producing excessive head.

Trimming should be restricted to about 75% of a pump's maximum impeller diameter, as excessive trimming can lead to a mismatched impeller and casing.

- Moreover, the impeller should not be trimmed any smaller than the minimum diameter shown on the manufacturer's curve. It is also a good idea to consult with the pump manufacturer before changing the impeller diameter.

Trimming reduces the impeller's tip speed, which subsequently reduces the amount of energy imparted to the pumped fluid. Consequently, the pump's flow rate and pressure both decrease.

A word of caution: Once an impeller is replaced with a trimmed version, the load on the motor will be lower, and it is necessary to determine how the efficiency of the more lightly loaded motor will be affected. A motor replacement with a lower capacity model may be worthwhile.

Example 6 – Calculation of Energy Savings Associated with Trimmed Impeller

A centrifugal pump equipped with a 14.0 inch diameter impeller is throttled to provide a process cooling water flow rate of 3,100 USGPM. The pumping system operates for 8,200 hours per year with a head of 170 feet and pump efficiency (η) of 82%. At this point, the pump was measured to require 162 BHP. Pump and system curves indicate that a

12 How to Optimize Pump Systems

trimmed impeller can supply the 3,100 USGPM required flow rate at a head of 121 feet. Using the affinity laws, at the same flow rate, the new diameter of the trimmed impeller is calculated approximately as follows:

$$\begin{aligned}\text{Impeller Diameter}_2 &= \text{Impeller Diameter}_1 \times \sqrt[3]{(\text{Head}_2 \div \text{Head}_1)} \\ &= 14.0 \times \sqrt[3]{(121 \div 170)} \\ &= 12.49 \text{ inches}\end{aligned}$$

Assuming that the pump efficiency (η) remains unchanged, installing a 12½ inch trimmed impeller reduces input power requirement to the following:

$$\begin{aligned}\text{Brake Horsepower}_2 &= (\text{Head}_2 \times \text{Flow}_2) \div (3960 \times \eta) \\ &= (121 \times 3,100) / (3,960 \times 0.82) \\ &= 115.5 \text{ BHP}\end{aligned}$$

80

The estimated energy savings, using a 92% motor efficiency factor, is as follows:

$$\begin{aligned}\text{Annual Energy Savings} &= [(\text{Brake HP}_1 - \text{Brake HP}_2) \times 0.746 \times \text{Annual Operating Hours}] \div (\text{Motor Efficiency}) \\ &= (162.0 - 115.5) \times 0.746 \text{ kW/hp} \times 8,200 \text{ hours/year} \div 0.92 \\ &= 309,200 \text{ kWh/year}\end{aligned}$$

Using an electricity cost of 10 cents per kWh, total energy cost savings are estimated to be \$30,920 per year.

13 TROUBLESHOOTING CHECKLIST

Pumping systems that operate inefficiently display many symptoms. In diagnosing the symptoms one should keep in mind that the presence of a symptom does not confirm the existence of a problem, but rather, it highlights the probability of a problem existing. Common symptoms that crop up time after time through simple walkthroughs or monitoring of pumping systems include:

- **Continuous pump operation in a batch environment.** Pumps that run continuously when the fundamental nature of the system requirement is of a batch nature may simply be left running even when they aren't needed for convenience and little more. One example of this would be a pump that runs 24 hours a day even though the load that requires the pump is only present during one or two shifts.
- **Frequent cycling of pumps in a continuous process.** Some pumps cycle on and off, typically to maintain level or inventory. If pumps display frequent cycling so that they only run a relatively small amount (for example 40% of the time), it is worthwhile to investigate both associated static and dynamic loads.
- **Multiple parallel pumps with the same number of pumps always operating.** Multiple pumps are used in parallel to provide redundancy and/or to provide flexibility in responding to changing load conditions. If two pumps are installed for redundancy, and both

13 Troubleshooting Checklist

normally operate, there is a strong possibility that the pumps were not well-sized or that they have degraded.

- **Open bypass lines.** Open bypass or recirculation lines are sometimes used for control purposes. In a few cases, a combination of concurrent throttling and bypass flow control is found.
- **Systems that have undergone a change in function or demand.** In situations where system requirements increase with time, pumps are normally upsized to meet the growing demand. On the other hand, if requirements drop, the pump that was presumably properly sized will often be left operating (oversized for the job).
- **Throttled valves.** Valves that are consistently throttled to control flow rate, pressure, level, temperature or some other parameter in the system provide direct evidence that energy is being dissipated in the fluid.

APPENDIX A - TROUBLESHOOTING PUMP PERFORMANCE

The following Pump Troubleshooting table has been adapted from “Pumps Reference Guide – Third Edition,” Ontario Power Generation 1999.

Symptom	Possible Cause
Excessive Power Consumption	<ul style="list-style-type: none"> ▪ discharge pressure higher than calculated ▪ electrical or mechanical defect in submerged motor ▪ higher fluid viscosity than specified ▪ improperly adjusted packing gland (too tight) causing drag ▪ incorrect lubrication of driver ▪ lubricant in shaft enclosing tube too heavy (vertical turbine) ▪ mechanical defects (shaft bent, rotating element binds) on shaft ▪ pump running too fast ▪ rotating element binding from misalignment ▪ specific gravity or viscosity of liquid pumped is too high ▪ speed too high ▪ stuffing boxes too tight, wearing rings worn ▪ system head higher than rating, pumps too little or too much liquid ▪ undersized submersible cable ▪ where required, the extra clearances on rotating elements
Excessive Vibration and Noise	<ul style="list-style-type: none"> ▪ bearings failing ▪ bearings starting to fail ▪ bent shaft ▪ coupling misalignment ▪ damaged components: impeller, shaft, packing, coupling ▪ foreign material in pump causing imbalance ▪ foundation and/or hold down bolts loose ▪ loose components, valves, guards, brackets ▪ misalignment conditions ▪ piping inadequately supported ▪ pump cavitation due to vaporization in inlet line ▪ pump over or under rated capacity

Appendix A – Troubleshooting Pump Performance

	<ul style="list-style-type: none"> ▪ pump starved on high viscosity fluid ▪ relief valve chatter ▪ suction lift too high ▪ unstable foundation
Excessive Wear of Liquid or Power End Parts	<ul style="list-style-type: none"> ▪ abrasive or corrosive action of the liquid ▪ incorrect material ▪ liquid in power end ▪ overloading ▪ poor lubrication
Fails to Deliver Required Capacity	<ul style="list-style-type: none"> ▪ air leaking into pump ▪ broken valve springs ▪ capacity of booster pump less than displacement of power pump ▪ clogged suction strainer ▪ insufficient NPSH_a ▪ internal bypass in liquid cylinder ▪ liquid cylinder valves, seats, piston packing, liner, rods or plungers worn ▪ makeup in suction tank less than displacement of pump ▪ one or more cylinders not pumping ▪ pump not filling ▪ pump valve stuck open ▪ relief, bypass, pressure valves leaking ▪ speed incorrect, belts slipping ▪ stuck foot valve ▪ suction lift too great ▪ vortex in supply tank
Insufficient Discharge	<ul style="list-style-type: none"> ▪ air leak in inlet line or packing ▪ air leaks in suction or stuffing boxes and air entry to pump ▪ bypass valve partially open damaged ▪ end of inlet line not sufficiently submerged causing eddies ▪ excessive lift on rotor element ▪ foot valve of suction opening not submerged enough ▪ impeller installed backwards ▪ impeller partially plugged ▪ impeller(s) loose on shaft ▪ insufficient NPSH_a

Appendix A - Troubleshooting Pump Performance

	<ul style="list-style-type: none"> ▪ leaking joints ▪ mechanical defects (wearing rings worn, impeller) ▪ net inlet pressure too low overloaded ▪ partial air blockage suction or casing ▪ pump worn ▪ speed too low, motor may be wired improperly or cavitating ▪ strainer partially clogged or of insufficient area ▪ suction or discharge valve(s) partially closed ▪ system head higher than anticipated ▪ wrong direction rotation
Insufficient Pressure	<ul style="list-style-type: none"> ▪ air or gas in liquid ▪ excessive lift on rotor element ▪ impeller diameter too small ▪ impeller installed backwards ▪ impeller speed too low ▪ leaking joints (well application) ▪ mechanical defects: wearing rings worn; ▪ system head lower than anticipated ▪ wrong direction of rotation
Loss of Prime (After Satisfactory Operation)	<ul style="list-style-type: none"> ▪ air leaks developed in suction line ▪ fluid supply exhausted ▪ fluid vaporizes in inlet line, fluid may be overheated ▪ substantial increase in fluid viscosity
Loss of Suction Following Period of Satisfactory Operation	<ul style="list-style-type: none"> ▪ air or gas in liquid ▪ casing gasket defective ▪ clogging of strainer ▪ excessive well drawdown ▪ leaky suction line ▪ suction lift too high or insufficient NPSH_a ▪ water seal plugged
No Discharge	<ul style="list-style-type: none"> ▪ air leak in inlet or suction line or stuffing box ▪ broken line shaft or coupling ▪ bypass valve open ▪ closed suction valve

Appendix A – Troubleshooting Pump Performance

	<ul style="list-style-type: none"> ▪ end of inlet pipe not submerged in fluid ▪ foot valve stuck ▪ impeller completely plugged ▪ impeller installed backwards ▪ impeller(s) loose on shaft ▪ loose coupling, broken shaft, failed pump ▪ net inlet pressure too low ▪ pump badly worn ▪ pump damaged during installation (wells) ▪ pump not primed ▪ speed too low ▪ strainer clogged ▪ suction lift higher than that for which pump is designed ▪ system head too high ▪ valves closed or obstruction in inlet or outlet line ▪ well drawdown below minimum submergence ▪ wrong direction of rotation
<p>Not enough liquid</p>	<ul style="list-style-type: none"> ▪ Delivery hose punctured or blocked ▪ Discharge head too high ▪ Impeller excessively worn ▪ Incorrect engine speed ▪ Mechanical seal drawing air into pump ▪ Obstruction in pump casing/impeller ▪ Suction hose collapsed ▪ Suction inlet or strainer blocked ▪ Suction lift too great ▪ Suction line not air tight
<p>Packing Failure</p>	<ul style="list-style-type: none"> ▪ improper installation ▪ improper or inadequate lubrication ▪ improper packing selection ▪ packing too tight ▪ plunger or rod misalignment ▪ scored plungers or rods ▪ worn or oversized stuffing box bushings
<p>Pump ceases to</p>	<ul style="list-style-type: none"> ▪ Delivery hose punctured or blocked ▪ Excessive air leak in suction line

Appendix A - Troubleshooting Pump Performance

<p>deliver liquid after a time</p>	<ul style="list-style-type: none"> ▪ Insufficient water at suction inlet ▪ Mechanical seal / packing drawing air into pump ▪ Obstruction in pump casing/impeller ▪ Suction hose collapsed ▪ Suction inlet or strainer blocked ▪ Suction lift too great
<p>Pump does not prime</p>	<ul style="list-style-type: none"> ▪ Compressor belt drive faulty ▪ Compressor not delivering sufficient air ▪ Compressor pipe leaking air ▪ Ejector jet or nozzle blocked or badly worn ▪ Ejector non-return valve ball stuck ▪ Insufficient water at suction inlet ▪ Mechanical seal / packing drawing air into pump ▪ Non return valve ball not seating ▪ Separation tank cover blocked ▪ Suction hose collapsed ▪ Suction inlet or strainer blocked ▪ Suction lift too great ▪ Suction line not air tight
<p>Pump leaking at seal housing</p>	<ul style="list-style-type: none"> ▪ Mechanical seal damaged or worn
<p>Pump takes excessive power</p>	<ul style="list-style-type: none"> ▪ Engine speed too high ▪ Obstruction between impeller and casing ▪ Viscosity and / or SG of liquid being pumped too high
<p>Pump vibrating or overheating</p>	<ul style="list-style-type: none"> ▪ Engine speed too high ▪ Obstruction in pump casing/impeller ▪ Impeller damaged ▪ Cavitation due to excessive suction lift

APPENDIX B – PUMP ASSESSMENT MEMORY JOGGER

Pump Energy Consumption Formula

Energy consumption in pumps is calculated using the following formula:

$$\text{Energy Consumption} = (\text{Flow} \times \text{Head} \times \text{Time} \times \text{Specific Gravity}) \div (5308 \times \eta_{\text{pump}} \times \eta_{\text{motor}} \times \eta_{\text{drive}})$$

Where:

Energy Consumption	= Energy, kilowatt hours
Flow	= flow rate, USGPM
Head	= head, feet
Time	= time, hours
Specific Gravity	= specific gravity, dimensionless
5308	= Units conversion constant
η_{pump}	= pump efficiency, fraction
η_{motor}	= motor efficiency, fraction
η_{drive}	= drive efficiency, fraction

Common Causes for Non-Optimal Pump Operation

The most common and fundamental reasons why pump systems operate at less than optimal levels are:

- Installed components are inherently inefficient at the normal operating conditions.
- The installed components have degraded in service.
- More flow is being provided than the system requires.

Appendix B – Pump Assessment Memory Jogger

- More head is being provided than the system requires.
- The pump is being run when not required by the system.

High Level Pump System Diagnosis

In an initial pump assessment, the initial systems and components to examine and the symptoms to look for include:

- Throttle valve-controlled systems.
- Bypass (recirculation) line normally left open.
- Multiple parallel pump system, with same number of pumps always kept operating.
- Constant pump operation in a batch environment or frequent cycle batch operation in a continuous process.
- Cavitation noise at pump or elsewhere in the system.
- High system maintenance requirements.
- Systems that have undergone change in function since the original pump installation.

APPENDIX C – PUMP IMPROVEMENT MEASURES

Improvement Measure	Actions and Benefit
Determine Actual Flow Requirements	<ul style="list-style-type: none"> ▪ Determine if any of the existing duty cycle flow requirements are unnecessary. ▪ Define if any existing requirements are excessive.
Use Speed Modulation	<p>Control equipment speed by:</p> <ul style="list-style-type: none"> ▪ varying the motor speed that is coupled directly to the load (e.g. ASDs, multi-speed motors, DC motors); ▪ coupling a fixed-speed driver to the load via a device that permits speed adjustment of the load, (e.g. fluid drives, gear systems and adjustable belt drives).
Upgrade Equipment where Appropriate	<p>Consider pump upgrades with component or application upgrades in these areas:</p> <ul style="list-style-type: none"> ▪ higher efficiency pumps may now be available; ▪ pump reselection may result in better efficiency at the new points of operation; ▪ replace worn impellers.
Use High Efficiency Motors	<p>Pump equipment generally operates more efficiently if an existing motor is replaced with a high efficiency motor or one closer to its current operating conditions.</p>
Reduce Impeller Diameter	<p>Pumps may operate against partially closed control valves. By resizing the impeller horsepower requirements are reduced as power requirements are proportional to impeller diameter.</p>
Consider Booster 'Pony' Applications	<p>Consider using a booster pump for systems that operate during infrequent peaks or upset conditions. The main equipment can then operate at maximum efficiency under normal conditions.</p>
Eliminate System Effect Factors	<p>Pumping systems cannot operate efficiently when there are poor inlet and outlet conditions. Eliminating or reducing poor external factors can have a considerable effect on performance improvement and energy savings.</p>

Appendix C – Pump Improvement Measures

Improvement Measure	Actions and Benefit
Eliminate Pump Cavitation	Cavitation reduces energy performance, flow capacity, pressure and efficiency. Performance can be improved usually by modifying inlet conditions such as by elevating the supply tank.
Use High Performance Lubricants	High performance lubricants can increase energy efficiency by reducing frictional losses and improving temperature stability.
Coatings	Application of coatings on system components such as pump impellers, casings and inner linings of pipes can reduce frictional losses and boost efficiency.
Adjust Internal Running Clearances	Internal clearances between rotating and non-rotating components strongly influence the pump's ability to achieve rated performance. Proper installation and commissioning reduces the level of recirculation from the discharge to the suction region of the impeller.
Implement System Maintenance	Pump systems suffer actual performance loss because to dirt accumulation on components like filters, coils and impellers.
Install and Maintain Process Control	<p>Pumps should be utilized to optimize flows in an efficient manner based on actual requirements. This can be achieved by:</p> <ul style="list-style-type: none"> ▪ shutting down pumps when they are not required. ▪ controlling flows to prevent capacity usage not required for the process. ▪ eliminating recirculation modes where possible. ▪ closing pipe runs when they are not needed.

APPENDIX D – CONVERSION FACTORS

Area	1 in ² = 645.2mm ² 1 ft ² = 0.0929 m ²
Density	1 oz. = 28.35 g 1 lb/ft ³ = 16.02 kg/m ³
Gravitational Constant	32.2 feet per second per second 9.81 meters per second per second
Length	1 in = 25.4 mm 1 ft = 0.3048 m
Mass	1 lb = 0.4536 kg
Power	1 hp = 0.7457 kW
Pressure	1 in W.G. = 0.2484 kPa W.G. @ 68°F 1 in Hg = 3.386 kPa, Hg @ 32°F 1 psi = 6.895 kPa 1 kPa = 1000 N/m ² 1 atm = 14.696 psi 1 bar = 14.504 psi 1 in Hg = 13.63 in W.G.
Temperature	1 °F = 0.556 °C 0 °C Corresponds to 32 °F, 273.2 K and 491.7 R For °F to °C : TC = (TF - 32) × .556 For °F to °R : TR = TF + 459.7 For °C to °K : TK = TC + 273.2
Velocity	1 fpm = 5.08 × 10 ⁻³ m/s 1 ft/s = 0.3048 m/s
Volume Flow	1 CFM = 0.4719 × 10 ⁻³ m ³ /s 1 Imperial GPM = 0.2728 m ³ /hr = 4.546 L/min 1 US GPM = 0.2271 m ³ /hr = 3.785 L/min
Volume	1 ft ³ = 0.02832 m ³ 1 Imperial Gallon = 4.546 L 1 US Gallon = 3.785 L 1 L = 1 × 10 ⁻³ m ³ 1 US Gallon = 0.13368 ft ³ 1 Imperial Gallon = 1.20095 US Gallon

Appendix D – Conversion Factors

APPENDIX E - GLOSSARY OF COMMON PUMP TERMS

Term	Definition
Adjustable Speed Drive	A mechanical, hydraulic or electric system used to match motor speed to changes in process load requirements.
Best Efficiency Point	The operating point of a centrifugal pump where the efficiency is at a maximum point (BEP).
Cavitation	Cavitation occurs when pressure in the suction line falls below vapour pressure inside the pump. These vapour bubbles or cavities collapse when they reach regions of higher pressure on their way through the pump. The most obvious effects of cavitation are noise and vibration.
Design Point	A point of operation generally based on a duty that is slightly higher than the highest duty ever expected for the application. This point represents a specific set of criteria used to select the pump.
Dynamic or Total Head	In-flowing fluid, the sum of the static and velocity pressures at the point of measurement.
Friction Loss	The amount of pressure / head required to 'force' liquid through pipe and fittings.
Head	Head is a quantity used to express a form or combinations of forms of the energy content of the liquid per unit weight of the liquid. All head quantities have the dimensions of feet (or meters) of liquid.
Horsepower (HP)	The measure of work equivalent to lifting 550 lbs one foot in one second, or 745.7 Watts.
Load Duty Cycle	The relationship between the operating time and rest time, or repeatable operation at different loads.
Motor	A device that takes electrical energy and converts it into mechanical energy to turn a shaft.

Appendix E – Glossary of Common Pump Terms

Term	Definition
Net Positive Suction Head (NPSH)	The amount of pressure in excess of the fluid vapour pressure required to prevent the formation of vapour pockets.
Net Positive Suction Head Available (NPSH _a)	NPSH _a is a characteristic of the pumping system. It is defined as the energy that is in a liquid at the suction connection of the pump.
Net Positive Suction Head Required (NPSH _r)	NPSH _r is the energy needed to fill a pump on the suction side and overcome the frictional and flow losses from the suction connection to that point in the pump at which more energy is added.
Performance Curve	A plot of the pump performance characteristics from zero delivery to free flow.
Operating Point	The point where the system curve intersects the pressure and flow curve on the turbo machine's actual performance curve.
Pressure	Pressure is the force exerted per unit area of a fluid. The most common units for designating pressure are pounds per square inch (psi) or kilo Pascals (kPa). There are three designations of pressure: gauge, atmospheric and absolute.
Specific Gravity or S.G.	Weight of liquid in comparison to water at approximately 20 °C (S.G. = 1.0).
Specific Speed	A number which is the function of pump flow, head and efficiency. Pumps with similar specific speed will have similar shaped curves, similar efficiency, NPSH and solids handling characteristics.
Speed Modulation	A control process whereby the speed of a rotating machine is varied between preset speeds to maintain a control setpoint.
Static Head	The vertical height difference from centerline of impeller to discharge point is termed as discharge static head. The vertical height difference from surface of water source to discharge point is termed as total static head.

Appendix E – Glossary of Common Pump Terms

Term	Definition
Static Pressure	The pressure with respect to a surface at rest in relation to the surrounding fluid.
Static Suction Head	The total system head on the suction side of a pump with zero flow (can be positive or negative).
System	The combination of turbo machinery and the connected piping, valves and other hardware through which flow occurs.
System Losses	Pressure drop across system hardware components.
System Resistance	Resistance to flow resulting from the pressure drop and frictional losses of all system hardware.
Throttling	An irreversible adiabatic process that involves lowering the pressure of a fluid without work to control flow rate.
Total Pressure	The sum of the static pressure and the velocity pressure at the point of measurement.
Turbo Machinery	Equipment that uses rotating elements to impart work on a transported medium, or that uses the energy in a flowing medium to impart work on an external load.
Vapour Pressure	The vapour pressure of a liquid at a specified temperature is the pressure at which the liquid is in equilibrium with the atmosphere or with its vapour in a closed container.
Velocity Pressure	The pressure at a point in a fluid existing by virtue of its density and its rate of motion.
Viscosity	A measure of a liquid's flow resistance (or thickness). Viscosity determines the type of pump selected, the speed it can run at, and with gear pumps, the internal clearances required.

APPENDIX F – BIBLIOGRAPHY AND WEB LINKS

Print References

Addison H., Pollack F. *Pump User's Handbook, 2nd ed.*, Morden, England: Trade and Technical Press Ltd., 1980.

Anderson H.H. *Centrifugal Pumps, 3rd ed.* Morden, England: Trade and Technical Press Ltd., 1980.

Hydraulic Institute *Standards for Centrifugal, Rotary, and Reciprocating Pumps, 14th ed.* Cleveland OH: Hydraulic Institute, 1983.

Karassik I.J. (ed.). *Pump Handbook, 2nd ed.* New York: McGraw-Hill Book Company, 1986.

Ontario Power Generation, *Pumping Reference Handbook, 3rd edition*, 1993.

Perry's Chemical Engineer's Handbook, 6th ed. R.H., Green D.W. (eds.). New York: McGraw-Hill Book Company, 1984.

Sulzer Brothers Ltd., *Sulzer Centrifugal Pump Handbook*, Elsevier Science Publishers Ltd, London, 1989.

U.S. Department of Energy, 1998. *United States Industrial Motor Systems Market Opportunities Assessment*. Washington, D.C.: U.S. Department of Energy, Office of Industrial Technologies.

Appendix F – Bibliography and Web Links

US Department of Energy, 1999. *Improving Pumping System Performance: A Sourcebook for Industry*. Washington, D.C.: U.S. Department of Energy, Office of Industrial Technologies.

Weblinks (verified December 2007)

BC Hydro

<http://www.bchydro.com/business/investigate/investigate865.html>

Hydro Quebec

http://www.hydroquebec.com/business/appui_pmi/index.html

Manitoba Hydro Pumps

<http://www.hydro.mb.ca/pop/pumps.shtml>

Natural Resources Canada

<http://www.oee.nrcan.gc.ca/industrial/cipec.cfm>

Pump Systems Matter™

<http://www.pumpsystemsmatter.org>

Hydraulic Institute

<http://www.pumps.org>

APPENDIX G – PUMP MEASURE / SAVINGS WORKSHEET

PUMP AUDIT DATA SHEET

Audit Date: _____

System Information	
System or Location: _____	Annual Hours of Operation: _____ hrs
System Description: _____	

Pump Information	
Pump Manufacturer: _____	Pump Age: _____ yrs
Pump Model: _____	
Rated Input power: _____ hp or kW <small>(circle one)</small>	Rated Speed: _____ RPM
Actual Flow: _____ USGPM <small>(if available)</small>	Actual Pressure: _____ psig <small>(if available)</small>
Max. (rated) Flow: _____ USGPM	Max. (rated) Pressure: _____ psig
Impeller Diameter: _____ inches	Pump Inlet Diameter: _____ inches
	Pump Outlet Diameter: _____ inches
Pump Type: Positive Displacement Single Entry Centrifugal Double Entry Centrifugal Axial <small>(Circle one)</small>	
Other: (specify) _____	

Pump Drive and Controls							
Pump Throttle: _____ % open	control	Auto	Manual	Fixed			
Pump Bypass: _____ % open	or	Auto	Manual	Fixed			
	adjustment:	Auto	Manual	Fixed			
	<small>(circle)</small>						
Variable Speed Drive: No Yes <small>(circle one)</small>	if yes, Type: <small>(circle one)</small>	ASD	Eddy-Current	Hydraulic coupling	Wound Rotor	_____ %	speed
Motor-Pump Coupling: <small>(circle one)</small>	Direct Drive	Belt Drive	_____ pulley ratio	Adjustable sheaves? Yes No	Gear Reducer	_____ gear ratio	gear ratio

Motor Information	
Motor Manufacturer: _____	Motor Age: _____ yrs
Motor Model: _____	
Nameplate Data: _____ hp	_____ RPM
_____ Volts	_____ NEMA
_____ FLA	_____ % Efficiency

Load Factor and Energy Cost	
Average Cost of power _____ \$ / kWh	

Formula: Three-phase power (kW) = 1.732 x Amps x Volts x Power Factor/1000
 Average Annual Operating Cost (\$) = Average power (kW) x Annual Operating hours x Average Cost of Power (\$/kWh)

Load Duty Cycle									
Operating Point	(% or USGPM)	Hours per year	Motor Amps	Motor Volts	Discharge Pressure	Pump Speed	Power Factor*	Input Power (kW)	Average Cost (\$)
1									-
2									-
3									-
4									-
5									-
Annual Totals		-							-

* Tip: Power factor (PF) varies with motor load; estimate the PF at the operating point from manufacturer's data sheets or use typical values

INDEX

- adjustable speed drives, 43, 46, 50
- Adjustable Speed Drives, 12, 28, 49, 51
- API Pump, 22
- ASD. *See* Adjustable Speed Drive
- best efficiency point, 21, 33, 45, 48
- Blow Case Pumps, 24
- Bypass Valves, 43
- Capacity, 15, 20, 84
- Cavitation, 38, 87, 90, 92, 95
- Centrifugal Pumps, 19, 99
- Connected in Parallel, 56
- Connected in Series, 55
- Control Valves, 63
- Design Point, 95
- Dynamic head, 16, 28, 30
- Efficiency, 1, 10, 12, 20, 33, 49, 52, 53, 60, 61, 62, 80, 91, 106
- Energy Optimization, 59
- friction head, 15, 28, 30, 50
- Head, 20, 35, 36, 39, 48, 52, 64, 65, 70, 75, 76, 89, 95, 96, 97
- Hydraulic Horsepower, 48
- Inefficient Pumps, 77
- Input power, 20
- Kinetic, 17, 18, 19
- Load Duty Cycle, 95
- net positive suction head, 38
- NPSH. *See* Net Positive Suction Head
- on/off control, 16
- PD. *See* Positive Displacement
- Performance Curve, 96
- Pipe Diameter, 62
- pony pump, 47
- Positive Displacement, 17, 23
- Pressure, 34, 35, 64, 76, 85, 93, 96, 97
- Pump Affinity Laws, 34
- Pump Curves, 30, 32
- Pump Instability, 66
- Pump Optimization, 73, 75
- Reciprocating Pumps, 24, 99
- Rotodynamic, 17, 19, 21, 31
- Specific gravity, 14
- Specific Gravity, 48, 64, 70, 89, 96
- Speed Control, 44, 47
- Speed of Rotation, 20
- static head, 16, 28, 29, 30, 34, 36, 37, 42, 43, 49, 50, 51, 62, 96
- System Curve, 45
- System Optimization, 71
- Throttle Valves, 41
- throttling, 12, 16, 42, 45, 49, 60, 64, 78, 82
- Throttling, 42, 63, 97
- Total System Head, 16
- Trimming Impellers, 78
- Turbine Pump, 21
- Vapour pressure, 14
- Viscosity, 14, 87, 97
- Vortex Pump, 21

Your feedback and comments are appreciated.

Please provide suggestions to:

info@ceati.com

Energy Efficiency is Good Business

- Economic Prosperity
- Environmental Performance
- Social Responsibility
- Security